

TRAFFIC IMPACT ANALYSIS

**CAPISTRANO GREENERY AT PRIMA DESHECHA LANDFILL
SAN JUAN CAPISTRANO, CALIFORNIA**



February 2020

TRAFFIC IMPACT ANALYSIS

CAPISTRANO GREENERY AT PRIMA DESHECHA LANDFILL SAN JUAN CAPISTRANO, CALIFORNIA

Submitted to:

John Arnau
OC Waste & Recycling
300 North Flower Street, Suite 400
Santa Ana, California 92703

Prepared by:

LSA
20 Executive Park, Suite 200
Irvine, California 92614-4731
(949) 553-0666

Project No. OCY1701.15



February 2020

EXECUTIVE SUMMARY

The purpose of this Traffic Impact Analysis (TIA) is to determine the potential traffic impacts resulting from the proposed Capistrano Greenery composting operation within the Prima Deshecha Landfill at 32250 Avenida La Pata in San Juan Capistrano, California.

The existing Prima Deshecha Landfill is open from 7:00 a.m. to 5:00 p.m., Monday through Saturday. The landfill currently receives approximately 100 tons per day of processed green material (PGM). Approximately 5 daily trucks (with a 20-ton capacity), generating an average daily traffic (ADT) of 10, are utilized for the intake of 100 tons per day of PGM. The designated truck route to/from the Prima Deshecha Landfill and regional locations is Interstate 5 (I-5), Ortega Highway (State Route 74 [SR-74]), and Avenida La Pata.

The proposed Capistrano Greenery (project) would have the same hours of operation as the existing landfill. The new composting operation would include the intake of an additional 100 tons per day of PGM and the composting of approximately 200 tons of PGM per day on site. The increase of 100 tons per day of PGM would require 5 daily trucks, generating 10 ADT. After the composting process is complete, 200 tons of compost would be delivered to markets inside and outside Orange County. The daily compost delivery would require approximately 10 trucks, generating 20 ADT. The total project would require 15 trucks, generating 30 ADT.

Based on the current Prima Deshecha Landfill hours of operation (10 hours between 7:00 a.m. and 5:00 p.m.), this would equate to approximately 1.5 trucks per hour. Applying a passenger car equivalent (PCE) factor of 2 per truck to the 15 daily trucks, the project would generate approximately 60 ADT, with 6 trips in the a.m. peak hour (3 inbound and 3 outbound) and 6 trips in the p.m. peak hour (3 inbound and 3 outbound) in PCEs. The remaining 48 PCE trips (24 inbound and 24 outbound) would occur outside the peak-hour periods.

This study focuses on the a.m. peak-hour and p.m. peak-hour levels of service (LOS) at seven intersections and daily LOS at five roadway segments. Project impacts were determined based on an analysis of Existing and Existing Plus Project conditions.

Based on the results of this analysis, the project can be implemented without impacting the design or operation of the surrounding roadway system. An evaluation of intersection and roadway LOS shows that the addition of project traffic to the Existing condition would not significantly impact the study area locations, according to the City of San Juan Capistrano (City) performance criteria.

TABLE OF CONTENTS

EXECUTIVE SUMMARY.....	i
TABLE OF CONTENTS	ii
FIGURES AND TABLES	iii
LIST OF ABBREVIATIONS AND ACRONYMS.....	iv
INTRODUCTION	1
Project Site	1
Study Area Boundary.....	1
ANALYSIS METHODOLOGY	4
Intersection LOS Methodologies	4
Roadway Segment LOS Methodology	5
Threshold of Significance	5
PROPOSED PROJECT TRAFFIC	6
Trip Generation	6
Trip Distribution and Assignment.....	6
EXISTING CONDITIONS	6
Existing Circulation System	6
Existing Traffic Volumes and Levels of Service.....	8
EXISTING PLUS PROJECT CONDITIONS	9
Existing Plus Project Traffic Volumes and LOS	9
CONCLUSIONS	9
REFERENCES	18

APPENDICES

- A: EXISTING TRAFFIC VOLUMES
- B: ICU WORKSHEETS
- C: HCM WORKSHEETS

FIGURES AND TABLES

FIGURES

Figure 1: Regional and Project Location	2
Figure 2: Site Plan	3
Figure 3: Project Trip Distribution and Assignment	7
Figure 4: Existing Peak-Hour Volumes.....	10
Figure 5: Existing Plus Project Peak-Hour Volumes.....	14

TABLES

Table A: Project Trip Generation	6
Table B: Existing Intersection Level of Service Summary (ICU)	11
Table C: Existing Intersection Level of Service Summary (HCM).....	12
Table D: Existing Roadway Segment Level of Service Summary	13
Table E: Existing Plus Project Intersection Level of Service Summary (ICU)	15
Table F: Existing Plus Project Intersection Level of Service Summary (HCM)	16
Table G: Existing Plus Project Roadway Segment Level of Service Summary	17

LIST OF ABBREVIATIONS AND ACRONYMS

ADT	average daily traffic
CEQA	California Environmental Quality Act
City	City of San Juan Capistrano
CMP	Congestion Management Program
HCM	<i>Highway Capacity Manual</i>
I-5	Interstate 5
ICU	intersection capacity utilization
LOS	level(s) of service
MPAH	Master Plan of Arterial Highways
mph	miles per hour
NDS	National Data & Surveying Services
OCTA	Orange County Transportation Authority
PCE	passenger car equivalent
PGM	processed green material
project	Capistrano Greenery project
SR-74	State Route 74
TIA	Traffic Impact Analysis
TRB	Transportation Research Board
v/c	volume-to-capacity
vph	vehicles per hour

TRAFFIC IMPACT ANALYSIS CAPISTRANO GREENERY

LSA has prepared the following Traffic Impact Analysis (TIA) to identify the potential traffic impacts resulting from the proposed Capistrano Greenery composting operation within the Prima Deshecha Landfill at 32250 Avenida La Pata in San Juan Capistrano, California. LSA has prepared this analysis in accordance with the City of San Juan Capistrano (City) Administrative Policy No. 310 (revised 1998), the City's General Plan Circulation Element and Growth Management Element (1999), the Orange County Congestion Management Program (CMP) (OCTA 2017), and applicable provisions of the California Environmental Quality Act (CEQA).

INTRODUCTION

Project Site

Figure 1 shows the project location. The existing Prima Deshecha Landfill is open from 7:00 a.m. to 5:00 p.m., Monday through Saturday. The landfill does not currently have a composting operation. The proposed Capistrano Greenery (project) would have the same hours of operation. The landfill currently receives approximately 100 tons per day of processed green material (PGM). The proposed project would include the intake of an additional 100 tons per day of PGM and the composting of approximately 200 tons of PGM per day on site.

Figure 2 illustrates a site plan of the project. After the composting process is complete, 200 tons of compost would be delivered to markets inside and outside Orange County. The project would require approximately 15 trucks, generating an average daily traffic (ADT) of 60 in passenger car equivalents (PCEs). The designated truck route to/from the Prima Deshecha Landfill and regional locations is Interstate 5 (I-5), Ortega Highway (State Route 74 [SR-74]), and Avenida La Pata.

Study Area Boundary

As shown on Figure 1, the study area includes the following intersections:

1. I-5 southbound ramps/Ortega Highway
2. I-5 northbound ramps/Ortega Highway
3. Rancho Viejo Road/Ortega Highway
4. La Novia Avenue/Ortega Highway
5. Reata Road/Ortega Highway
6. Antonio Parkway–Avenida La Pata/Ortega Highway
7. Avenida La Pata/Stallion Ridge

The study area also includes the following Ortega Highway roadway segments:

1. I-5 southbound ramps to I-5 northbound ramps
2. I-5 southbound ramps to Rancho Viejo Road
3. Rancho Viejo Road to La Novia Avenue
4. La Novia Avenue to Calle Entradero
5. Calle Entradero to Reata Road
6. Reata Road to Antonio Parkway–Avenida La Pata

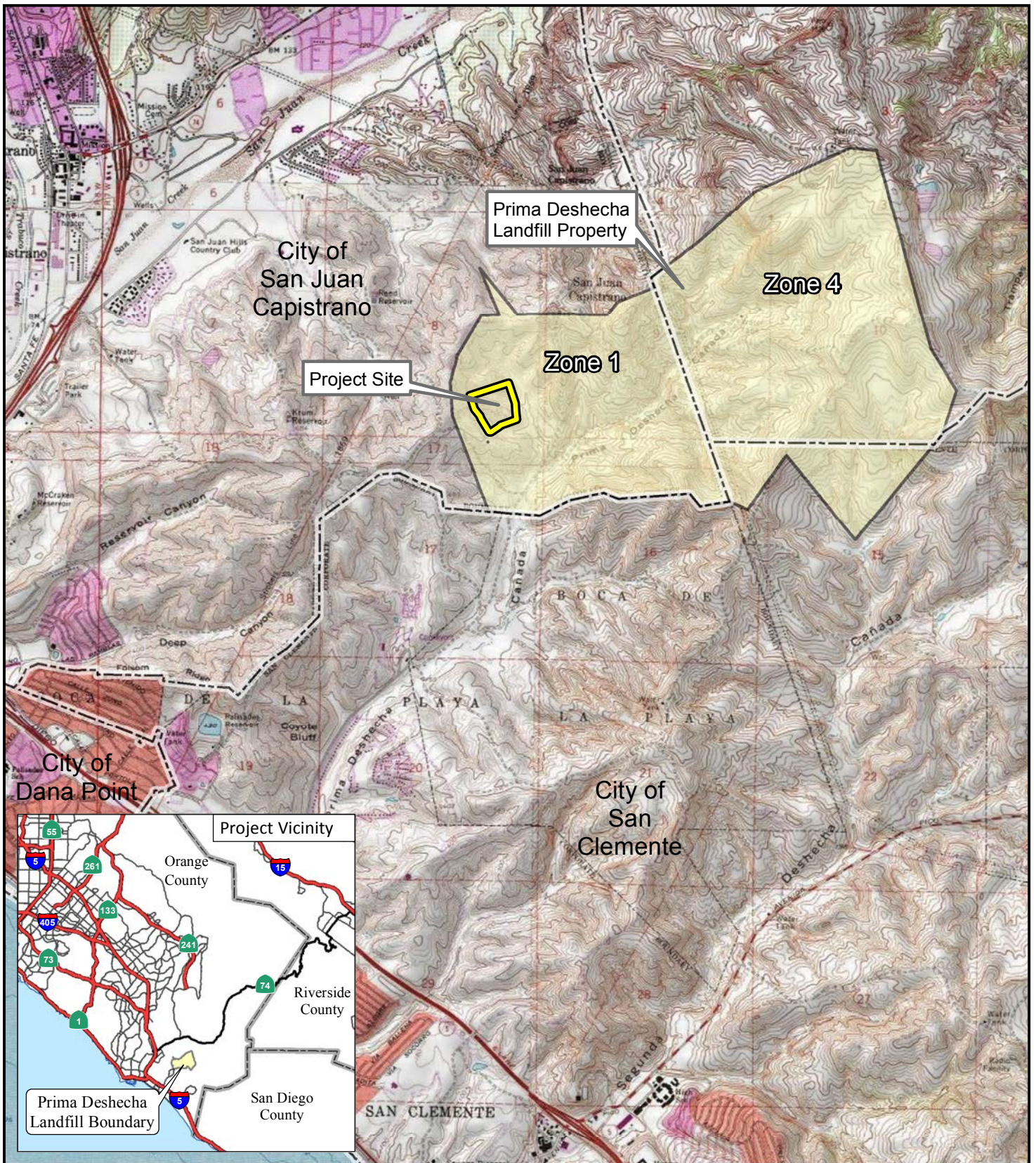
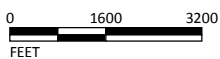

FIGURE 1

LSA

LEGEND

- Prima Deshecha Landfill Boundary
- Project Site



SOURCE: USGS 7.5' QUAD - Canada Gobernadora (1988); Dana Point (1975); San Clemente (1975), CA

I:\OCY1701.15\GIS\MXD\ProjectLocation_USGS.mxd (7/25/2019)

Capistrano Greenery at
Prima Deshecha Landfill
Regional and Project Location

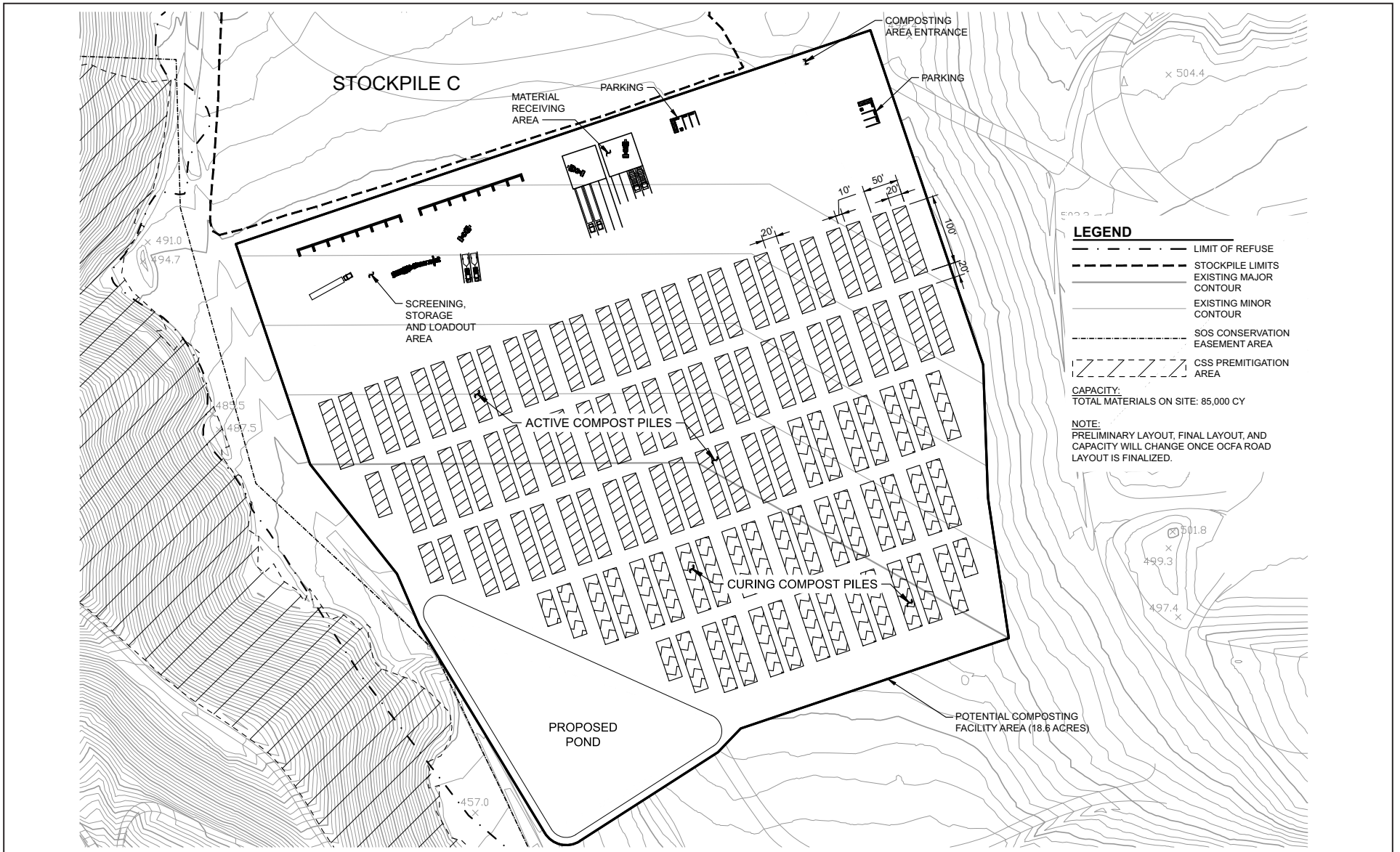
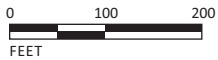

FIGURE 2

LSA



SOURCE: Tetra Tech

I:\OCY1701.15\G\Site Plan.cdr (7/26/2019)

Capistrano Greenery at
Prima Deshecha Landfill
Site Plan

ANALYSIS METHODOLOGY

Intersection LOS Methodologies

Per City Administrative Policy No. 310, intersections are evaluated using both the intersection capacity utilization (ICU) and the *Highway Capacity Manual* (HCM), 6th Edition (TRB 2017) methodologies.

The ICU methodology for signalized intersections compares the volume-to-capacity (v/c) ratios of conflicting turn movements at an intersection, sums up these critical conflicting v/c ratios for each intersection approach, and determines the overall ICU. The ICU calculations assume a lane capacity of 1,700 vehicles per hour (vph) and a clearance interval (or loss time) of 0.05. The resulting ICU is expressed in terms of level of service (LOS), where LOS A represents free-flow activity and LOS F represents overcapacity operation.

The relationship between LOS and the ICU value (i.e., v/c ratio) is as follows:

Level of Service	Volume-to-Capacity (ICU Methodology)
A	≤0.60
B	>0.60 and ≤0.70
C	>0.70 and ≤0.80
D	>0.80 and ≤0.90
E	>0.90 and ≤1.00
F	>1.00

ICU = Intersection Capacity Utilization

In addition to the ICU methodology for calculating intersection LOS, the HCM methodology was used. The HCM intersection methodology presents LOS in terms of delay (in seconds per vehicle). The resulting delay is expressed in terms of LOS, as in the ICU methodology. The relationship between LOS and the delay for signalized intersections is shown below:

Level of Service	Signalized Intersection Delay (seconds) per Vehicle (HCM Methodology)
A	≤10.0
B	>10.0 and ≤20.0
C	>20.0 and ≤35.0
D	>35.0 and ≤55.0
E	>55.0 and ≤80.0
F	>80.0

HCM = *Highway Capacity Manual* (TRB 2017)

TRB = Transportation Research Board

The study area intersection LOS analysis was conducted for the weekday a.m. peak hour (between 7:00 a.m. and 9:00 a.m.) and weekday p.m. peak hour (between 4:00 p.m. and 6:00 p.m.).

The City requires an HCM operational analysis of study area intersections designated as “hot spots” using the Synchro computer software package. Intersections designated as hot spots are closely

spaced and experience high volumes during the peak hours. The peak 30-minute volumes in the a.m. and p.m. peak-hour periods are multiplied by 2 to represent the peak-hour volumes at the hot-spot intersections. This analysis is conducted to evaluate the impacts of the proposed project on the signal operations of these locations. In addition to the hot-spot locations, LSA utilized Synchro (version 10) for the HCM analysis of all other study area intersections.

Roadway Segment LOS Methodology

Roadway segment v/c ratios were determined using the daily capacities contained in the 2018 Orange County Transportation Authority (OCTA) *Guidance for Administration of the Orange County Master Plan of Arterial Highways* (MPAH). Facility types were taken from the City’s General Plan and the MPAH. The following table illustrates daily capacities for roadways in the study area:

Facility Type	Number of Lanes	Capacity
Major	8	75,000
Major	6	56,300
Primary	4 (Divided)	37,500
Secondary	4 (Undivided)	25,000
Limited Secondary	2 (Divided)	20,000
Local Arterial	2 (Undivided)	12,500

Threshold of Significance

The City considers LOS D as the upper limit of satisfactory operations for intersections and roadway segments. However, as indicated in the City’s General Plan Circulation Element, the following intersections and roadway segments are identified as hot-spot locations (i.e., School hot spot, Operations hot spot, and Space Constrained hot spot), where LOS E is considered satisfactory:

Hot Spot Intersections

1. I-5 northbound ramps/Ortega Highway
2. I-5 southbound ramps/Ortega Highway

Hot Spot Roadway Segment

1. Ortega Highway between the I-5 southbound ramps and I-5 northbound ramps

Both intersections are Orange County CMP intersections, and Ortega Highway is a CMP roadway. LOS E is considered acceptable at these locations, consistent with the City’s target LOS for hot-spot locations.

Based on City Administration Policy No. 310, a project impact occurs at a non-hot-spot intersection (or roadway segment) when the project’s increase in ICU (or v/c ratio) is 0.01 or greater and the resulting LOS is E or F (ICU methodology). A project impact also occurs at a non-hot-spot intersection when the project’s increase in delay is 1.0 second or greater and the resulting LOS is E or F (HCM methodology).

A project impact occurs at a hot-spot intersection (or roadway segment) when the project’s increase in ICU (or v/c ratio) is 0.01 or greater and the resulting LOS is F. A project impact also occurs at a hot-spot intersection when the project’s increase in delay is 1.0 second or greater and the resulting LOS is F.

PROPOSED PROJECT TRAFFIC

Trip Generation

The trip generation from the project is based on operational information from OC Waste & Recycling. As previously described, the additional intake of 100 PGM and the daily delivery of 200 tons of compost would require 15 total trucks. Based on the current hours of operation of the Prima Deshecha Landfill (10 hours between 7:00 a.m. and 5:00 p.m.), this equates to approximately 1.5 trucks per hour. A PCE factor of 2 has been assumed for each of the 15 daily trucks.

As shown in Table A, the project would generate 60 ADT, with 6 trips in the a.m. peak hour (3 inbound, 3 outbound) and 6 trips in the p.m. peak hour (3 inbound, 3 outbound) in PCEs. The remaining 48 trips (24 inbound, 24 outbound) would occur outside the peak-hour periods.

Table A: Project Trip Generation

Trip Type	Quantity	PCE	ADT	AM Peak Hour			PM Peak Hour		
				In	Out	Total	In	Out	Total
Trucks	15	2	60	3	3	6	3	3	6

Source: OC Waste & Recycling (July 2019).

ADT = average daily traffic

PCE = passenger car equivalent

The project trips have been added to the existing traffic volumes to represent the Existing Plus Project conditions.

Trip Distribution and Assignment

The directions of approach to and departure from the site are based on operational information from OC Waste & Recycling and the City’s designated truck routes (e.g., I-5, Ortega Highway, and Avenida La Pata). Approximately 50 percent of the trips are destined north on I-5 and 50 percent are destined south on I-5. The results of the impact analysis and the access analysis are discussed later in this TIA. Figure 3 illustrates the project trip distribution and assignment.

EXISTING CONDITIONS

Existing Circulation System

Key roadways in the vicinity of the project are as follows:

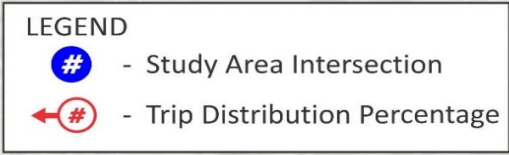
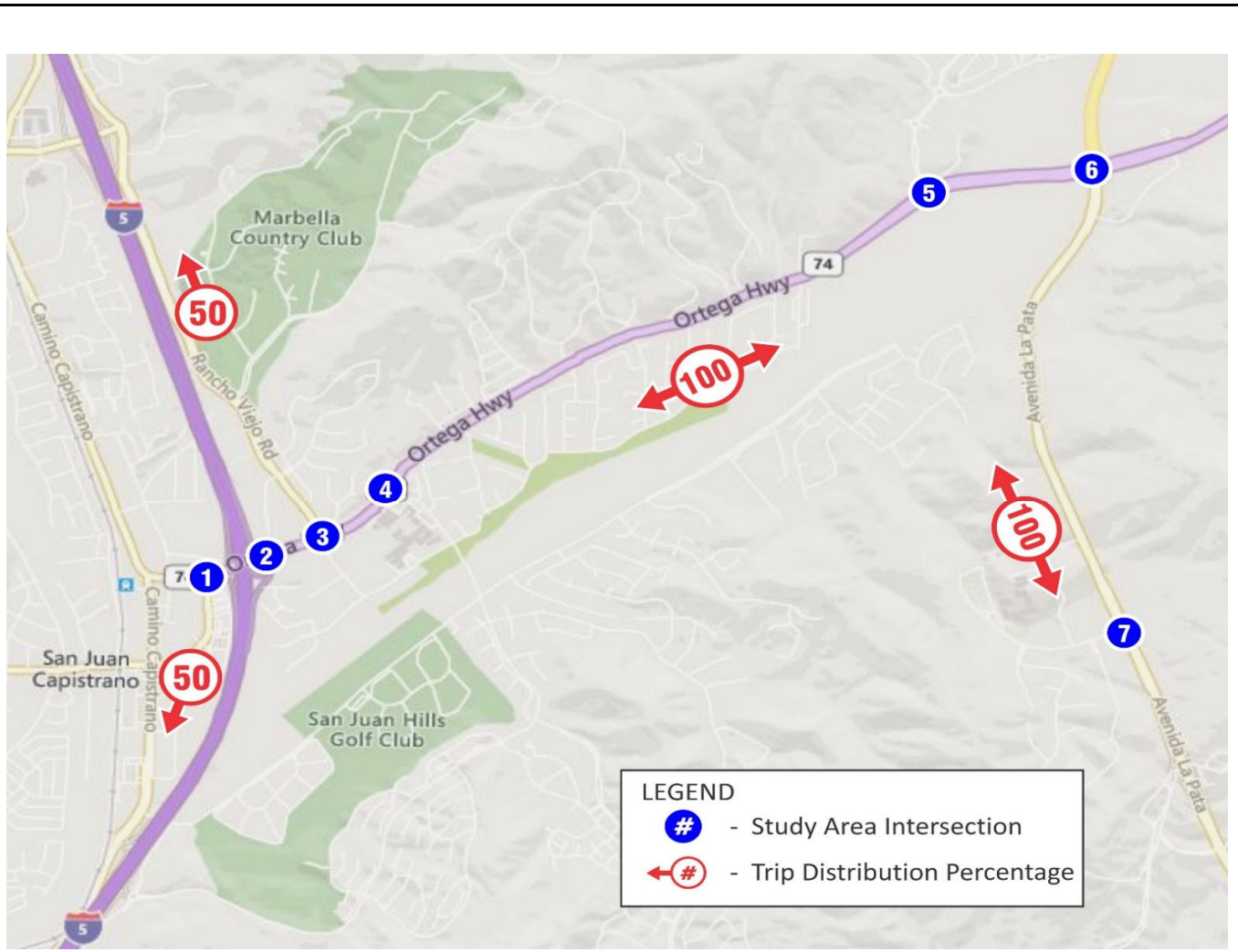

LSA

LEGEND
 xxx / yyy AM / PM Volume
 NB = northbound
 SB = southbound

FIGURE 3

Capistrano Greenery at Prima Deshecha Landfill
 Project Trip Distribution and Assignment

- **Ortega Highway:** Ortega Highway is an east-west roadway located north of the project site. Ortega Highway is divided west of Antonio Parkway–Avenida La Pata and undivided east of Antonio Parkway–Avenida La Pata. It extends east from Camino Capistrano west of I-5 to Interstate 215 in Perris. Ortega Highway is designated as a Primary Arterial in the City’s Circulation Element. Ortega Highway is a CMP facility and is designated as a hot-spot location west of the I-5 northbound ramps. Between the I-5 northbound and southbound ramps, Ortega Highway functions as an eight-lane facility due to the dual left-turn lanes at the signalized I-5 southbound ramps/Ortega Highway intersection. Between the I-5 northbound ramps and Antonio Parkway–Avenida La Pata, the number of Ortega Highway lanes vary between two lanes and six lanes. The speed limit along Ortega Highway west of Antonio Parkway–Avenida La Pata is 35–45 miles per hour (mph). Curbside parking is not permitted.
- **I-5:** I-5 is a north-south interstate freeway located west of the project site. I-5 has 10 travel lanes in the project vicinity, of which 4 lanes are general-purpose lanes and 1 lane is a high-occupancy vehicle lane in each direction.
- **Avenida La Pata:** Avenida La Pata is a divided north-south roadway east of the project site. It has four to six travel lanes. The speed limit along Avenida La Pata is 55 mph. On-street (Class II) bicycle lanes are provided on both sides of the street. Curbside parking is not permitted.
- **Reata Road:** Reata Road is a divided two-lane roadway that connects Ortega Highway to residential neighborhoods north of Ortega Highway. On-street (Class II) bicycle lanes are provided on both sides of the street. Curbside parking is not permitted.
- **La Novia Avenue:** La Novia Avenue is an undivided four-lane, north-south roadway located northwest of the project site. La Novia Avenue is designated as a Primary Arterial in the City’s Circulation Element. The speed limit along La Novia Avenue is 35 mph (25 mph adjacent to the St. Margaret’s Episcopal School when children are present). Curbside parking is not permitted on either side of La Novia Avenue.
- **Rancho Viejo Road:** Rancho Viejo Road is a four-lane, north-south roadway located northwest of the project site. It is generally divided with a raised median (and left-turn lanes for access to local streets) north of Ortega Highway and undivided south of Ortega Highway. Rancho Viejo Road is designated as a Secondary Arterial north of Ortega Highway and a Collector south of Ortega Highway in the City’s Circulation Element. The speed limit along Rancho Viejo Road north and south of Ortega Highway is 45 mph and 30 mph, respectively. Curbside parking is not permitted on either side of Rancho Viejo Road.

Existing Traffic Volumes and Levels of Service

Existing traffic volumes were collected by National Data & Surveying Services (NDS) and Wiltec in March and November 2018 for the study area intersections and roadway segments. Existing traffic volumes were collected in May 2017 for the intersection of Avenida La Pata/Stallion Ridge.

Per discussion with City staff, a growth rate of 4.3 percent per year was applied to the entering/exiting traffic volumes to/from the San Juan Hills High School for the intersection of Avenida La Pata/Stallion Ridge due to the 4.3 percent increase per year in student enrollment. Appendix A provides the existing traffic volume data. The existing a.m. and p.m. peak-hour turn movement volumes for the study area intersections are shown on Figure 4.

Tables B and C summarize the results of the existing peak-hour LOS analysis for the study area intersections using the ICU and HCM methodologies, respectively. The existing ICU and HCM worksheets are contained in Appendices B and C, respectively. As shown in Table B, all study area intersections, including the hot-spot intersections, currently operate at satisfactory LOS based on the ICU methodology. As shown in Table C, all study area intersections, including the hot-spot intersections, currently operate at satisfactory LOS based on the HCM methodology.

Existing roadway segment ADT volumes, v/c ratios, and LOS are presented in Table D. As Table D indicates, all study area roadway segments currently operate at satisfactory LOS with the exception of Ortega Highway from Calle Entradero to Reata Road (LOS F).

EXISTING PLUS PROJECT CONDITIONS

Existing Plus Project Traffic Volumes and LOS

To determine the Existing Plus Project condition, traffic generated by the proposed project was added to existing baseline traffic volumes at the study area intersections. Figure 5 shows the resulting Existing Plus Project peak-hour traffic volumes.

Tables E and F summarize the results of the Existing Plus Project peak-hour LOS analysis for the study area intersections using the ICU and HCM methodologies, respectively. The Existing Plus Project ICU and HCM worksheets are contained in Appendices B and C, respectively. As shown in Table E, all study area intersections, including the hot-spot intersections, are anticipated to operate at satisfactory LOS based on the ICU methodology. As shown in Table F, all study area intersections, including the hot-spot intersections, are anticipated to operate at satisfactory LOS based on the HCM methodology. Therefore, a significant project impact would not occur at any study area intersection based on the ICU and HCM methodologies.

Existing Plus Project roadway segment ADT volumes, v/c ratios, and LOS are presented in Table G. As Table G indicates, all study area roadway segments are anticipated to operate at satisfactory LOS with the project with the exception of Ortega Highway from Calle Entradero to Reata Road (LOS F). However, the project would not increase the deficient v/c ratio by 0.01 or greater. Therefore, a significant project impact would not occur at any study area roadway segment.

CONCLUSIONS

The Capistrano Greenery project can be implemented without impacting the surrounding circulation system. The evaluation of the study area intersection and roadway segment LOS with the proposed project on site would not create any significant adverse impacts according to the City's performance criteria.

Table B: Existing Intersection Level of Service Summary (ICU)

Intersection		Control	Peak Hour	Existing	
				ICU	LOS
1	I-5 SB Ramps/Ortega Highway ¹	Signal	AM	0.644	B
			PM	0.680	B
2	I-5 NB Ramps/Ortega Highway ¹	Signal	AM	0.718	C
			PM	0.688	B
3	Rancho Viejo Road/Ortega Highway	Signal	AM	0.650	B
			PM	0.789	C
4	La Novia Avenue/Ortega Highway	Signal	AM	0.640	B
			PM	0.670	B
5	Reata Road/Ortega Highway	Signal	AM	0.594	A
			PM	0.562	A
6	Antonio Parkway–Avenida La Pata/Ortega Highway	Signal	AM	0.654	B
			PM	0.607	B
7	Avenida La Pata/Stallion Ridge	Signal	AM	0.424	A
			PM	0.308	A

¹ Intersection is considered a hot-spot location (LOS E is acceptable).

ICU = Intersection Capacity Utilization

LOS = level of service

NB = northbound

SB = southbound

Table C: Existing Intersection Level of Service Summary (HCM)

Intersection		Control	Peak Hour	Existing	
				Delay	LOS
1	I-5 SB Ramps/Ortega Highway ¹	Signal	AM	25.1	C
			PM	22.9	C
2	I-5 NB Ramps/Ortega Highway ¹	Signal	AM	44.5	D
			PM	38.9	D
3	Rancho Viejo Road/Ortega Highway	Signal	AM	44.2	D
			PM	49.3	D
4	La Novia Avenue/Ortega Highway	Signal	AM	21.4	C
			PM	21.5	C
5	Reata Road/Ortega Highway	Signal	AM	18.1	B
			PM	19.3	B
6	Antonio Parkway–Avenida La Pata/Ortega Highway	Signal	AM	37.5	D
			PM	30.6	C
7	Avenida La Pata/Stallion Ridge	Signal	AM	24.8	C
			PM	13.2	B

¹ Intersection is considered a hot-spot location (LOS E is acceptable).

HCM = *Highway Capacity Manual*

LOS = level of service

NB = northbound

SB = southbound



Table D: Existing Roadway Segment Level of Service Summary

Ortega Highway Segment	No. of Lanes	LOS E Capacity	Existing		
			ADT	V/C	LOS
I-5 SB Ramps to I-5 NB Ramps ^{1,2}	8D	75,000	43,468	0.580	A
I-5 NB Ramps to Rancho Viejo Road ¹	6D	56,300	49,586	0.881	D
Rancho Viejo Road to La Novia Avenue ¹	5D	46,900	42,410	0.904	E
La Novia Avenue to Calle Entradero ¹	4D	37,500	36,421	0.971	E
Calle Entradero to Reata Road ¹	2D	20,000	36,421	1.821	F
Reata Road to Antonio Parkway--Avenida La Pata ¹	4D	37,500	35,968	0.959	E

¹Segment is a CMP location (LOS E is acceptable).

²Segment is considered a hot-spot location (LOS E is acceptable).

ADT = average daily traffic

CMP = Congestion Management Program

D = divided

LOS = level of service

NB = northbound

SB = southbound

V/C = volume-to-capacity ratio

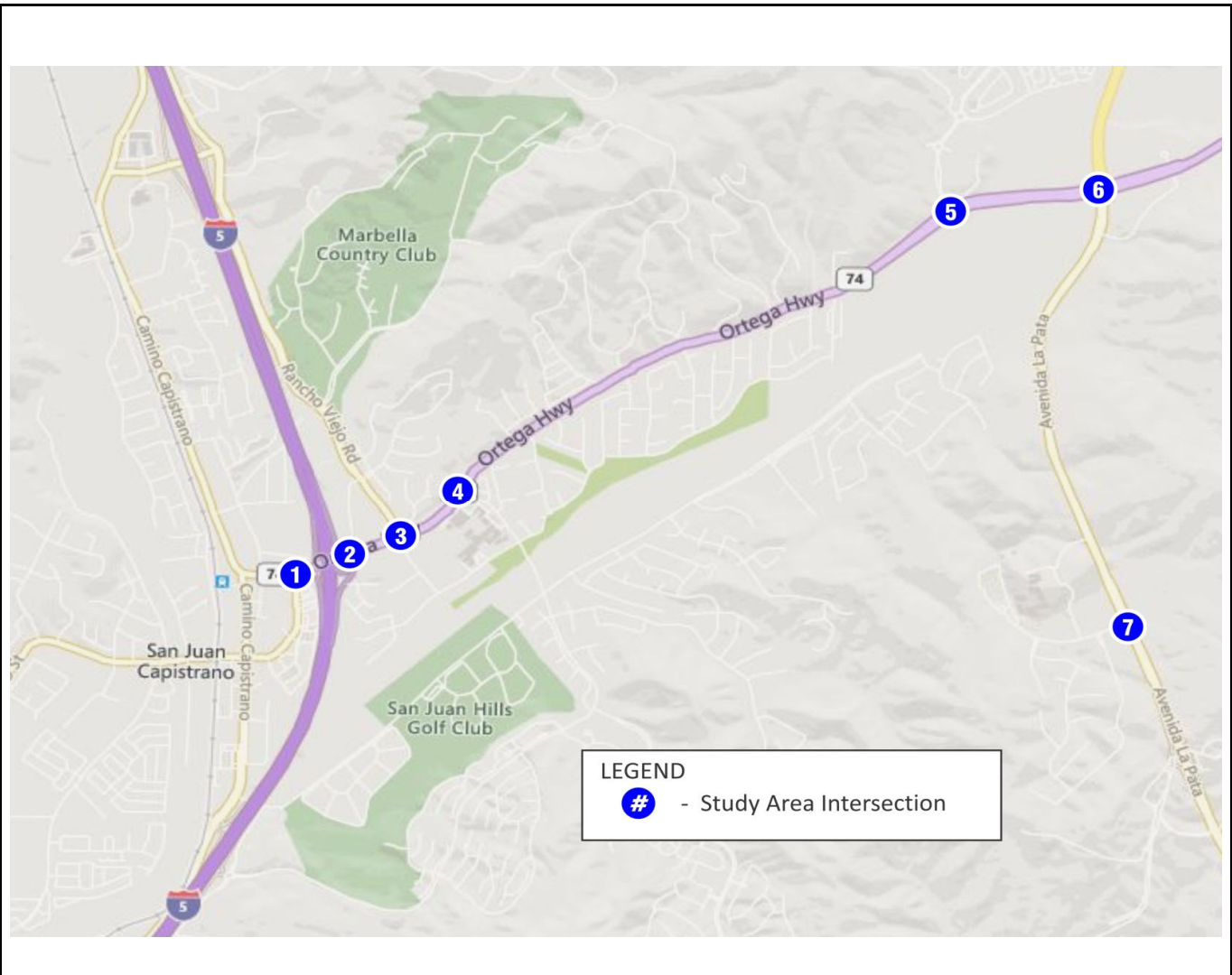

<p>1 I-5 SB Ramps/Ortega Hwy</p>	<p>2 I-5 NB Ramps/Ortega Hwy</p>	<p>3 Rancho Viejo/Ortega Hwy</p>	<p>4 La Novia Ave/Ortega Hwy</p>	<p>5 Reata Rd/Ortega Hwy</p>
<p>6 Ave La Pata/Ortega Hwy</p>	<p>7 Ave La Pata/Stallion Ridge</p>			



LEGEND
 xxx / yyy AM / PM Volume
 NB = northbound
 SB = southbound

FIGURE 5

Capistrano Greenery at Prima Deshecha Landfill
 Existing Plus Project Peak-Hour Volumes



Table E: Existing Plus Project Intersection Level of Service Summary (ICU)

Intersection	Control	Peak Hour	1		2		3	
			Existing		Existing Plus Project		Project Impact ²	
			ICU	LOS	ICU	LOS	ICU	Yes/No
1 I-5 SB Ramps/Ortega Highway ¹	Signal	AM	0.644	B	0.644	B	0.000	No
		PM	0.680	B	0.681	B	0.001	No
2 I-5 NB Ramps/Ortega Highway ¹	Signal	AM	0.718	C	0.719	C	0.001	No
		PM	0.688	B	0.689	B	0.001	No
3 Rancho Viejo Road/Ortega Highway	Signal	AM	0.650	B	0.651	B	0.001	No
		PM	0.789	C	0.790	C	0.001	No
4 La Novia Avenue/Ortega Highway	Signal	AM	0.640	B	0.641	B	0.001	No
		PM	0.670	B	0.671	B	0.001	No
5 Reata Road/Ortega Highway	Signal	AM	0.594	A	0.595	A	0.001	No
		PM	0.562	A	0.563	A	0.001	No
6 Antonio Parkway–Avenida La Pata/Ortega Highway	Signal	AM	0.654	B	0.655	B	0.001	No
		PM	0.607	B	0.607	B	0.000	No
7 Avenida La Pata/Stallion Ridge	Signal	AM	0.424	A	0.425	A	0.001	No
		PM	0.308	A	0.309	A	0.001	No

¹ Intersection is considered a hot-spot location (LOS E is acceptable).

² A significant project impact occurs when the ICU in (2) minus the ICU in (1) is 0.01 or greater and the LOS in (2) is E or F.

ICU = Intersection Capacity Utilization

LOS = level of service

NB = northbound

SB = southbound



Table F: Existing Plus Project Intersection Level of Service Summary (HCM)

	Intersection	Control	Peak Hour	1		2		3	
				Existing		Existing Plus Project		Project Impact ²	
				Delay	LOS	Delay	LOS	Delay	Yes/No
1	I-5 SB Ramps/Ortega Highway ¹	Signal	AM	25.1	C	25.1	C	0.0	No
			PM	22.9	C	22.9	C	0.0	No
2	I-5 NB Ramps/Ortega Highway ¹	Signal	AM	44.5	D	44.7	D	0.2	No
			PM	38.9	D	39.1	D	0.2	No
3	Rancho Viejo Road/Ortega Highway	Signal	AM	44.2	D	44.4	D	0.2	No
			PM	49.3	D	49.5	D	0.2	No
4	La Novia Avenue/Ortega Highway	Signal	AM	21.4	C	21.4	C	0.0	No
			PM	21.5	C	21.6	C	0.1	No
5	Reata Road/Ortega Highway	Signal	AM	18.1	B	18.1	B	0.0	No
			PM	19.3	B	19.4	B	0.1	No
6	Antonio Parkway–Avenida La Pata/Ortega Highway	Signal	AM	37.5	D	37.7	D	0.2	No
			PM	30.6	C	30.7	C	0.1	No
7	Avenida La Pata/Stallion Ridge	Signal	AM	24.8	C	24.8	C	0.0	No
			PM	13.2	B	13.2	B	0.0	No

¹ Intersection is considered a hot-spot location (LOS E is acceptable).

² A significant project impact occurs when the delay in (2) minus the delay in (1) is 1.0 seconds or greater and the LOS in (2) is E or F.

HCM = *Highway Capacity Manual*

LOS = level of service

NB = northbound

SB = southbound



Table G: Existing Plus Project Roadway Segment Level of Service Summary

Ortega Highway Segment	No. of Lanes	LOS E Capacity	1			Project ADT	2			3	
			Existing				Existing Plus Project			Project Impact ³	
			ADT	V/C	LOS		ADT	V/C	LOS	Δ V/C	Yes/No
I-5 SB Ramps to I-5 NB Ramps ^{1,2}	8D	75,000	43,468	0.580	A	30	43,498	0.580	A	0.000	No
I-5 NB Ramps to Rancho Viejo Road ¹	6D	56,300	49,586	0.881	D	60	49,646	0.882	D	0.001	No
Rancho Viejo Road to La Novia Avenue ¹	5D	46,900	42,410	0.904	E	60	42,470	0.906	E	0.002	No
La Novia Avenue to Calle Entradero ¹	4D	37,500	36,421	0.971	E	60	36,481	0.973	E	0.002	No
Calle Entradero to Reata Road ¹	2D	20,000	36,421	1.821	F	60	36,481	1.824	F	0.003	No
Reata Road to Antonio–Avenida La Pata ¹	4D	37,500	35,968	0.959	E	60	36,028	0.961	E	0.002	No

¹ Segment is a CMP location (LOS E is acceptable).

² Segment is considered a hot-spot location (LOS E is acceptable).

³ A significant project impact occurs when the V/C in (2) minus the V/C in (1) is 0.01 or greater and the LOS in (2) is E or F.

Δ = change

ADT = average daily traffic

CMP = Congestion Management Program

D = divided

LOS = level of service

NB = northbound

SB = southbound

V/C = volume-to-capacity ratio

REFERENCES

City of San Juan Capistrano. 1998. Administrative Policy No. 310. (Adopted June 27, 1989; revised April 7, 1998).

_____. 1999. General Plan. Circulation Element. Adopted December 14, 1999.

Orange County Transportation Authority (OCTA). 2017. *Congestion Management Program*.

LSA. 2017. *SR-74 Lower Ortega Highway Widening Project Traffic Study Report*. December.

Transportation Research Board (TRB). 1982. *NCHRP Report 255: Highway Traffic Data for Urbanized Area Project Planning and Design*. December.

_____. 2017. *Highway Capacity Manual*, 6th ed.

APPENDIX A

EXISTING TRAFFIC VOLUMES

National Data & Surveying Services

Intersection Turning Movement Count

Location: I-5 SB ramps & Ortega Hwy
 City: San Juan Capistrano
 Control: Signalized

Project ID: 18-01238-008
 Date: 11/13 - 11/15/2018

3-Day Average Total

NS/EW Streets:	I-5 SB ramps				I-5 SB ramps				Ortega Hwy				Ortega Hwy				
AM	NORTHBOUND				SOUTHBOUND				EASTBOUND				WESTBOUND				TOTAL
	NL	NT	NR	NU	SL	ST	SR	SU	EL	ET	ER	EU	WL	WT	WR	WU	
7:00 AM	0	0	0	0	187	0	143	0	0	221	27	0	69	143	0	0	790
7:15 AM	0	0	0	0	203	1	233	0	0	217	39	0	83	168	0	0	944
7:30 AM	0	0	0	0	178	0	254	0	0	283	44	0	82	184	0	0	1025
7:45 AM	0	0	0	0	256	0	214	0	0	298	53	0	72	142	0	0	1035
8:00 AM	0	0	0	0	238	1	199	0	0	276	38	0	79	130	0	0	961
8:15 AM	0	0	0	0	171	0	208	0	0	265	32	0	91	166	0	0	933
8:30 AM	0	0	0	0	166	0	162	0	0	232	33	0	79	148	0	0	820
8:45 AM	0	0	0	0	180	0	189	0	0	230	37	0	87	142	0	0	865
TOTAL VOLUMES:	NL	NT	NR	NU	SL	ST	SR	SU	EL	ET	ER	EU	WL	WT	WR	WU	TOTAL
APPROACH %'s:	0	0	0	0	1579	2	1602	0	0	2022	303	0	642	1223	0	0	7373
					49.61%	0.06%	50.33%	0.00%	0.00%	86.97%	13.03%	0.00%	34.42%	65.58%	0.00%	0.00%	
PEAK HR:	07:15 AM - 08:15 AM																TOTAL
PEAK HR VOL:	0	0	0	0	875	2	900	0	0	1074	174	0	316	624	0	0	3965
PEAK HR FACTOR:	0.000	0.000	0.000	0.000	0.854	0.500	0.886	0.000	0.000	0.901	0.821	0.000	0.952	0.848	0.000	0.000	0.958
							0.945				0.889				0.883		
PM	NORTHBOUND				SOUTHBOUND				EASTBOUND				WESTBOUND				TOTAL
	NL	NT	NR	NU	SL	ST	SR	SU	EL	ET	ER	EU	WL	WT	WR	WU	
4:00 PM	0	0	0	0	276	0	187	0	0	243	49	0	107	183	0	0	1045
4:15 PM	0	0	0	0	270	1	173	0	0	242	41	0	102	178	0	0	1007
4:30 PM	0	0	0	0	253	0	176	0	0	270	39	0	99	176	0	0	1013
4:45 PM	0	0	0	0	268	0	177	0	0	256	45	0	99	172	0	0	1017
5:00 PM	0	0	0	0	241	0	196	0	0	286	41	0	102	182	0	0	1048
5:15 PM	0	0	0	0	229	1	191	0	0	234	38	0	104	188	0	0	985
5:30 PM	0	0	0	0	228	1	195	0	0	253	34	0	97	171	0	0	979
5:45 PM	0	0	0	0	230	0	211	0	0	269	38	0	83	169	0	0	1000
TOTAL VOLUMES:	NL	NT	NR	NU	SL	ST	SR	SU	EL	ET	ER	EU	WL	WT	WR	WU	TOTAL
APPROACH %'s:	0	0	0	0	1995	3	1506	0	0	2053	325	0	793	1419	0	0	8094
					56.93%	0.09%	42.98%	0.00%	0.00%	86.33%	13.67%	0.00%	35.85%	64.15%	0.00%	0.00%	
PEAK HR:	04:15 PM - 05:15 PM																TOTAL
PEAK HR VOL:	0	0	0	0	1032	1	722	0	0	1054	166	0	402	708	0	0	4085
PEAK HR FACTOR:	0.000	0.000	0.000	0.000	0.956	0.250	0.921	0.000	0.000	0.921	0.922	0.000	0.985	0.973	0.000	0.000	0.974
							0.986				0.933				0.977		

National Data & Surveying Services

Intersection Turning Movement Count

Location: I-5 NB ramps & Ortega Hwy
 City: San Juan Capistrano
 Control: Signalized

11/13 - 11/15/2018

Project ID: 18-01238-009
 Date: 11/13 - 11/15/2018

3-Day Average Total

NS/EW Streets	I-5 NB ramps					I-5 NB ramps					Ortega Hwy				Ortega Hwy				I-5 NB Ramps					TOTAL							
	NORTHBOUND					SOUTHBOUND					EASTBOUND				WESTBOUND																
AM	0.3	0.3	1.3	0	0	1	0	1	0	0	1	2.5	0.5	0	0	0	2.5	0.5	0	0	0	0	0	0	0	0	0	0	0	0	
	NL	NT	NR	NU	NL2	SL	ST	SR	SU	SR2	EL	ET	ER	EU	EU2	WL	WT	WR	WU	WT2	E2U	E2L2	E2T2	E2R2	E2U2						
7:00 AM	28	6	91	0	0	7	0	5	0	12	6	258	124	0	0	0	174	15	0	248	0	0	0	0	0						
7:15 AM	48	5	94	0	0	9	0	7	0	12	6	301	136	0	0	0	226	18	0	257	0	0	0	0	0						
7:30 AM	63	5	104	0	0	6	0	9	0	15	5	291	158	0	0	0	207	16	0	266	0	0	0	0	0						
7:45 AM	26	6	162	0	1	6	0	4	0	20	9	365	166	0	0	0	150	15	0	259	0	0	0	0	0						
8:00 AM	36	7	177	0	1	8	0	5	0	20	8	361	145	0	1	0	163	14	0	268	0	0	0	0	0						
8:15 AM	38	9	106	0	1	8	0	8	0	18	9	299	150	0	0	0	217	16	0	274	0	0	0	0	0						
8:30 AM	30	7	106	0	0	5	0	8	0	23	6	249	134	0	1	0	177	28	0	254	0	0	0	0	0						
8:45 AM	37	10	128	0	0	10	0	6	0	16	8	276	129	0	1	0	178	16	0	238	0	0	0	0	0						
TOTAL VOLUMES:	NL	NT	NR	NU	NL2	SL	ST	SR	SU	SR2	EL	ET	ER	EU	EU2	WL	WT	WR	WU	WT2	E2U	E2L2	E2T2	E2R2	E2U2						
	316	55	968	0	3	59	0	52	0	136	57	2400	1142	0	3	0	1492	138	0	2064	0	0	0	0	0						
APPROACH %s:	23.55%	4.10%	72.13%	0.00%	0.22%	23.89%	0.00%	21.05%	0.00%	55.06%	1.58%	66.63%	31.70%	0.00%	0.08%	0.00%	40.39%	3.74%	0.00%	55.87%											
PEAK HR:	07:30 AM - 08:30 AM																														
PEAK HR VOL:	173	27	549	0	3	28	0	26	0	73	31	1316	619	0	1	0	737	61	0	1067	0	0	0	0	0						
PEAK HR FACTOR:	0.687	0.750	0.775	0.000	0.750	0.875	0.000	0.722	0.000	0.913	0.861	0.901	0.932	0.000	0.250	0.000	0.849	0.953	0.000	0.974	0.000	0.000	0.000	0.000	0.000						
										0.934					0.911					0.920											
PM	NORTHBOUND					SOUTHBOUND					EASTBOUND				WESTBOUND									TOTAL							
	0.3	0.3	1.3	0	0	1	0	1	0	0	1	2.5	0.5	0	0	0	2.5	0.5	0	0	0	0	0		0	0	0	0	0	0	0
	NL	NT	NR	NU	NL2	SL	ST	SR	SU	SR2	EL	ET	ER	EU	EU2	WL	WT	WR	WU	WT2	E2U	E2L2	E2T2	E2R2	E2U2						
4:00 PM	47	8	97	0	1	15	0	7	0	18	13	375	128	0	0	0	225	12	0	201	0	0	0	0	0						
4:15 PM	43	5	110	0	0	11	0	9	0	22	12	374	128	0	0	0	237	18	0	208	0	0	0	0	0						
4:30 PM	39	3	88	0	1	11	0	8	0	20	11	376	140	0	1	0	234	18	0	226	0	0	0	0	0						
4:45 PM	43	6	107	0	0	9	0	8	0	22	13	385	128	0	0	0	219	23	0	231	0	0	0	0	0						
5:00 PM	37	7	76	0	0	11	0	11	0	21	14	350	155	0	0	0	235	26	0	225	0	0	0	0	0						
5:15 PM	44	4	112	0	1	6	0	10	0	19	6	330	120	0	0	0	256	25	0	233	0	0	0	0	0						
5:30 PM	37	4	87	0	1	8	0	9	0	14	11	348	130	0	1	0	231	13	0	197	0	0	0	0	0						
5:45 PM	41	4	91	0	0	12	0	7	0	14	12	357	146	0	1	0	195	13	0	162	0	0	0	0	0						
TOTAL VOLUMES:	NL	NT	NR	NU	NL2	SL	ST	SR	SU	SR2	EL	ET	ER	EU	EU2	WL	WT	WR	WU	WT2	E2U	E2L2	E2T2	E2R2	E2U2						
	331	41	768	0	4	83	0	69	0	150	92	2895	1075	0	3	0	1832	148	0	1683	0	0	0	0	0						
APPROACH %s:	28.93%	3.58%	67.13%	0.00%	0.35%	27.48%	0.00%	22.85%	0.00%	49.67%	2.26%	71.22%	26.45%	0.00%	0.07%	0.00%	50.01%	4.04%	0.00%	45.95%											
PEAK HR:	04:15 PM - 05:15 PM																														
PEAK HR VOL:	162	21	381	0	1	42	0	36	0	85	50	1485	551	0	1	0	925	85	0	890	0	0	0	0	0						
PEAK HR FACTOR:	0.942	0.750	0.866	0.000	0.250	0.955	0.000	0.818	0.000	0.966	0.893	0.964	0.889	0.000	0.250	0.000	0.976	0.817	0.000	0.963	0.000	0.000	0.000	0.000	0.000						
										0.948					0.988					0.977											

National Data & Surveying Services

Intersection Turning Movement Count

Location: Rancho Viejo Rd & Ortega Hwy
City: San Juan Capistrano
Control: Signalized

Project ID: 18-01238-010
Date: 11/13 - 11/15/2018

3-Day Average Total

NS/EW Streets:	Rancho Viejo Rd				Rancho Viejo Rd				Ortega Hwy				Ortega Hwy				TOTAL
	NORTHBOUND				SOUTHBOUND				EASTBOUND				WESTBOUND				
AM	1.5	1	0.5	0	1.5	1	0.5	0	1	2	1	0	1	3	1	0	
	NL	NT	NR	NU	SL	ST	SR	SU	EL	ET	ER	EU	WL	WT	WR	WU	
7:00 AM	30	7	11	0	39	10	17	0	25	260	67	1	6	374	43	0	890
7:15 AM	38	10	9	0	46	20	25	0	26	278	83	1	10	416	65	0	1027
7:30 AM	49	13	9	0	42	26	26	0	37	272	72	0	9	403	97	0	1055
7:45 AM	59	31	9	0	37	33	24	0	54	313	149	2	13	360	96	0	1180
8:00 AM	90	40	24	0	51	50	25	0	53	298	202	0	26	347	100	0	1306
8:15 AM	77	45	13	0	38	21	26	0	64	230	115	0	14	377	118	0	1138
8:30 AM	43	18	12	0	40	20	34	0	62	220	101	1	18	405	105	0	1079
8:45 AM	48	16	13	0	33	23	40	0	57	210	119	1	19	343	79	0	1001
TOTAL VOLUMES:	NL	NT	NR	NU	SL	ST	SR	SU	EL	ET	ER	EU	WL	WT	WR	WU	TOTAL
APPROACH %'s:	60.78%	25.21%	14.01%	0.00%	43.70%	27.21%	29.09%	0.00%	11.21%	61.70%	26.92%	0.18%	2.99%	78.71%	18.29%	0.00%	8676
PEAK HR:	07:45 AM - 08:45 AM																TOTAL
PEAK HR VOL:	269	134	58	0	166	124	109	0	233	1061	567	3	71	1489	419	0	4703
PEAK HR FACTOR:	0.747	0.744	0.604	0.000	0.814	0.620	0.801	0.000	0.910	0.847	0.702	0.375	0.683	0.919	0.888	0.000	0.900
	0.748				0.792				0.843				0.937				
PM	1.5	1	0.5	0	1.5	1	0.5	0	1	2	1	0	1	3	1	0	
	NL	NT	NR	NU	SL	ST	SR	SU	EL	ET	ER	EU	WL	WT	WR	WU	
4:00 PM	111	34	23	0	64	35	71	0	38	353	86	1	13	263	52	0	1144
4:15 PM	101	25	26	0	65	30	75	0	40	374	98	1	13	292	53	0	1193
4:30 PM	115	25	25	0	79	33	70	0	41	353	87	2	10	265	52	0	1157
4:45 PM	93	22	23	0	66	27	61	1	38	360	87	0	13	305	57	0	1153
5:00 PM	116	23	25	0	85	24	72	0	36	270	84	1	12	278	51	0	1077
5:15 PM	106	23	29	0	69	34	60	0	40	319	115	1	17	283	42	0	1138
5:30 PM	117	23	34	0	73	26	55	0	36	307	115	2	9	242	38	0	1077
5:45 PM	95	20	26	0	55	31	38	0	38	337	106	3	11	220	39	0	1019
TOTAL VOLUMES:	NL	NT	NR	NU	SL	ST	SR	SU	EL	ET	ER	EU	WL	WT	WR	WU	TOTAL
APPROACH %'s:	67.78%	15.48%	16.75%	0.00%	42.80%	18.48%	38.65%	0.08%	8.15%	70.92%	20.64%	0.29%	3.73%	81.67%	14.60%	0.00%	8958
PEAK HR:	04:00 PM - 05:00 PM																TOTAL
PEAK HR VOL:	420	106	97	0	274	125	277	1	157	1440	358	4	49	1125	214	0	4647
PEAK HR FACTOR:	0.913	0.779	0.933	0.000	0.867	0.893	0.923	0.250	0.957	0.963	0.913	0.500	0.942	0.922	0.939	0.000	0.974
	0.927				0.930				0.955				0.925				

INTERSECTION CAR/PED/BIKE TRAFFIC COUNT RESULTS SUMMARY

CLIENT: LSA
 PROJECT: ORTEGA HIGHWAY (SR-74) - SAN JUAN CAPISTRANO
 DATE: TUESDAY MARCH 27, 2018
 PERIOD: 7:00 AM TO 9:00 AM
 INTERSECTION: N/S LA NOVIA AVENUE
 E/W ORTEGA HIGHWAY
 CITY: SAN JUAN CAPISTRANO

VEHICLE COUNTS

15 MIN COUNTS	1	2	3	3U	4	5	6	6U	7	8	9	9U	10	11	12	12U	TOTAL
PERIOD	SBRT	SBTH	SBLT	SBUT	WBRT	WBTH	WBLT	WBUT	NBRT	NBTH	NBLT	NBUT	EBRT	EBTH	EBLT	EBUT	TOTAL
700-715	0	0	0	0	0	345	27	0	16	0	63	0	24	267	0	0	742
715-730	0	0	0	0	0	380	49	0	59	0	86	0	53	263	0	0	890
730-745	0	0	0	0	0	379	80	0	82	0	115	0	110	261	0	0	1027
745-800	0	0	0	0	0	394	32	0	60	0	122	0	40	305	0	0	953
800-815	0	0	0	0	0	393	47	0	29	0	73	0	35	186	0	0	763
815-830	0	0	0	0	0	419	20	0	40	0	74	0	24	219	0	0	796
830-845	0	0	0	0	0	380	22	0	26	0	72	0	24	234	0	0	758
845-900	0	0	0	0	0	385	30	0	27	0	68	0	28	207	0	0	745
HOUR TOTALS	1	2	3	3U	4	5	6	6U	7	8	9	9U	10	11	12	12U	TOTAL
PERIOD	SBRT	SBTH	SBLT	SBUT	WBRT	WBTH	WBLT	WBUT	NBRT	NBTH	NBLT	NBUT	EBRT	EBTH	EBLT	EBUT	TOTAL
700-800	0	0	0	0	0	1498	188	0	217	0	386	0	227	1096	0	0	3612
715-815	0	0	0	0	0	1546	208	0	230	0	396	0	238	1015	0	0	3633
730-830	0	0	0	0	0	1585	179	0	211	0	384	0	209	971	0	0	3539
745-845	0	0	0	0	0	1586	121	0	155	0	341	0	123	944	0	0	3270
800-900	0	0	0	0	0	1577	119	0	122	0	287	0	111	846	0	0	3062

PEAK HOUR 715-815

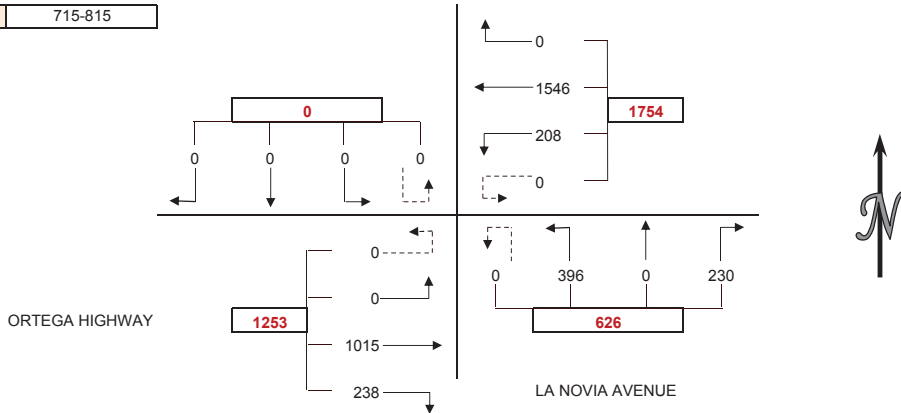

PEDESTRIAN COUNTS

15 MIN COUNTS	NORTH LEG	EAST LEG	SOUTH LEG	WEST LEG	TOTAL
700-715	0	0	0	0	0
715-730	0	0	1	0	1
730-745	0	0	0	0	0
745-800	0	1	0	0	1
800-815	0	1	1	0	2
815-830	0	1	1	0	2
830-845	0	1	0	0	1
845-900	0	0	0	0	0
HOUR TOTALS	NORTH LEG	EAST LEG	SOUTH LEG	WEST LEG	TOTAL
700-800	0	1	1	0	2
715-815	0	2	2	0	4
730-830	0	3	2	0	5
745-845	0	4	2	0	6
800-900	0	3	2	0	5

BICYCLE COUNTS

15 MIN COUNTS	NORTH LEG	EAST LEG	SOUTH LEG	WEST LEG	TOTAL
700-715	0	0	1	0	1
715-730	0	0	0	0	0
730-745	0	0	0	0	0
745-800	0	0	0	0	0
800-815	0	0	0	0	0
815-830	0	0	0	0	0
830-845	0	0	0	0	0
845-900	0	0	0	0	0
HOUR TOTALS	NORTH LEG	EAST LEG	SOUTH LEG	WEST LEG	TOTAL
700-800	0	0	1	0	1
715-815	0	0	0	0	0
730-830	0	0	0	0	0
745-845	0	0	0	0	0
800-900	0	0	0	0	0

APPROACH SUMMARIES

	NORTH APRCH		EAST APRCH		SOUTH APRCH		WEST APRCH	
	APRCH	EXIT	APRCH	EXIT	APRCH	EXIT	APRCH	EXIT
700-800	0	0	1686	1313	603	415	1323	1884
715-815	0	0	1754	1245	626	446	1253	1942
730-830	0	0	1764	1182	595	388	1180	1969
745-845	0	0	1707	1099	496	244	1067	1927
800-900	0	0	1696	968	409	230	957	1864

INTERSECTION CAR/PED/BIKE TRAFFIC COUNT RESULTS SUMMARY

CLIENT: LSA
 PROJECT: ORTEGA HIGHWAY (SR-74) - SAN JUAN CAPISTRANO
 DATE: TUESDAY MARCH 27, 2018
 PERIOD: 4:00 PM TO 6:00 PM
 INTERSECTION: N/S LA NOVIA AVENUE
 E/W ORTEGA HIGHWAY
 CITY: SAN JUAN CAPISTRANO

VEHICLE COUNTS

15 MIN COUNTS	1	2	3	3U	4	5	6	6U	7	8	9	9U	10	11	12	12U	TOTAL
PERIOD	SBRT	SBTH	SBLT	SBUT	WBRT	WBTH	WBLT	WBUT	NBRT	NBTH	NBLT	NBUT	EBRT	EBTH	EBLT	EBUT	TOTAL
400-415	0	0	0	0	0	263	31	0	43	0	71	0	39	420	0	0	867
415-430	0	0	0	0	0	256	41	0	30	0	49	0	56	406	0	0	838
430-445	0	0	0	0	0	268	32	0	57	0	74	0	41	329	0	0	801
445-500	0	0	0	0	0	264	25	0	37	0	46	0	40	361	0	0	773
500-515	0	0	0	0	0	254	23	0	46	0	61	0	42	316	0	0	742
515-530	0	0	0	0	0	290	42	0	38	0	47	0	37	382	0	0	836
530-545	0	0	0	0	0	224	22	0	68	0	68	0	32	378	0	0	792
545-600	0	0	0	0	0	230	40	0	49	0	57	0	28	407	0	0	811
HOUR TOTALS	1	2	3	3U	4	5	6	6U	7	8	9	9U	10	11	12	12U	TOTAL
PERIOD	SBRT	SBTH	SBLT	SBUT	WBRT	WBTH	WBLT	WBUT	NBRT	NBTH	NBLT	NBUT	EBRT	EBTH	EBLT	EBUT	TOTAL
400-500	0	0	0	0	0	1051	129	0	167	0	240	0	176	1516	0	0	3279
415-515	0	0	0	0	0	1042	121	0	170	0	230	0	179	1412	0	0	3154
430-530	0	0	0	0	0	1076	122	0	178	0	228	0	160	1388	0	0	3152
445-545	0	0	0	0	0	1032	112	0	189	0	222	0	151	1437	0	0	3143
500-600	0	0	0	0	0	998	127	0	201	0	233	0	139	1483	0	0	3181

PEAK HOUR 400-500

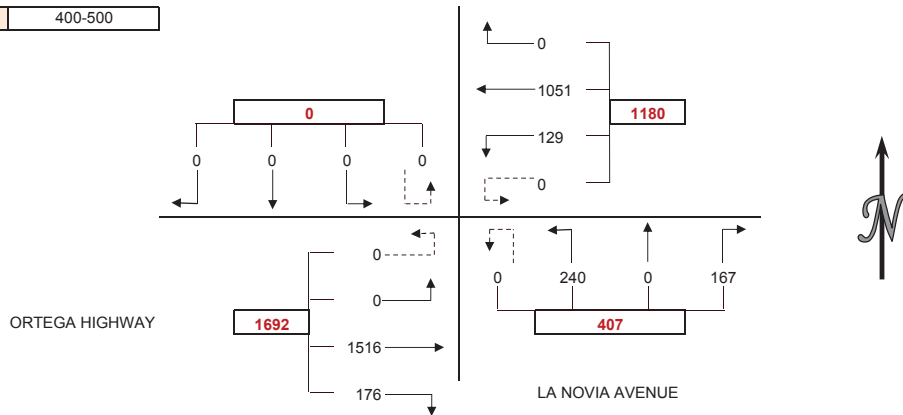

PEDESTRIAN COUNTS

15 MIN COUNTS	NORTH LEG	EAST LEG	SOUTH LEG	WEST LEG	TOTAL
400-415	0	0	0	0	0
415-430	0	0	0	0	0
430-445	0	0	0	0	0
445-500	0	0	1	0	1
500-515	0	0	0	0	0
515-530	0	2	0	0	2
530-545	0	2	0	0	2
545-600	0	0	0	0	0
HOUR TOTALS	NORTH LEG	EAST LEG	SOUTH LEG	WEST LEG	TOTAL
PERIOD	LEG	LEG	LEG	LEG	TOTAL
400-500	0	0	1	0	1
415-515	0	0	1	0	1
430-530	0	2	1	0	3
445-545	0	4	1	0	5
500-600	0	4	0	0	4

BICYCLE COUNTS

15 MIN COUNTS	NORTH LEG	EAST LEG	SOUTH LEG	WEST LEG	TOTAL
400-415	0	0	0	0	0
415-430	0	0	0	0	0
430-445	0	0	0	0	0
445-500	0	1	0	0	1
500-515	0	0	0	0	0
515-530	0	0	1	0	1
530-545	0	1	0	0	1
545-600	0	1	1	0	2
HOUR TOTALS	NORTH LEG	EAST LEG	SOUTH LEG	WEST LEG	TOTAL
PERIOD	LEG	LEG	LEG	LEG	TOTAL
400-500	0	1	0	0	1
415-515	0	1	0	0	1
430-530	0	1	1	0	2
445-545	0	2	1	0	3
500-600	0	2	2	0	4

APPROACH SUMMARIES

	NORTH APRCH		EAST APRCH		SOUTH APRCH		WEST APRCH	
	APRCH	EXIT	APRCH	EXIT	APRCH	EXIT	APRCH	EXIT
400-500	0	0	1180	1683	407	305	1692	1291
415-515	0	0	1163	1582	400	300	1591	1272
430-530	0	0	1198	1566	406	282	1548	1304
445-545	0	0	1144	1626	411	263	1588	1254
500-600	0	0	1125	1684	434	266	1622	1231

INTERSECTION CAR/PED/BIKE TRAFFIC COUNT RESULTS SUMMARY

CLIENT: LSA
 PROJECT: ORTEGA HIGHWAY (SR-74) - SAN JUAN CAPISTRANO
 DATE: TUESDAY MARCH 27, 2018
 PERIOD: 7:00 AM TO 9:00 AM
 INTERSECTION: N/S REATA ROAD
 E/W ORTEGA HIGHWAY
 CITY: SAN JUAN CAPISTRANO

VEHICLE COUNTS

15 MIN COUNTS	1	2	3	3U	4	5	6	6U	7	8	9	9U	10	11	12	12U	TOTAL
PERIOD	SBRT	SBTH	SBLT	SBUT	WBRT	WBTH	WBLT	WBUT	NBRT	NBTH	NBLT	NBUT	EBRT	EBTH	EBLT	EBUT	TOTAL
700-715	23	0	0	2	8	380	0	0	0	1	0	0	0	285	12	0	711
715-730	28	0	0	0	4	340	1	0	0	1	0	0	1	293	14	0	682
730-745	43	0	5	0	7	356	0	1	0	0	1	0	2	338	10	0	763
745-800	59	0	8	0	5	351	0	2	0	1	1	0	0	305	21	0	753
800-815	36	0	4	0	6	408	0	1	0	0	1	0	1	195	12	0	664
815-830	31	0	4	1	2	380	1	0	0	0	0	0	0	209	13	0	641
830-845	28	1	7	0	5	295	1	0	1	0	0	0	2	230	17	0	587
845-900	35	0	5	0	9	313	0	1	1	0	1	0	1	213	19	0	598
HOUR TOTALS	1	2	3	3U	4	5	6	6U	7	8	9	9U	10	11	12	12U	TOTAL
PERIOD	SBRT	SBTH	SBLT	SBUT	WBRT	WBTH	WBLT	WBUT	NBRT	NBTH	NBLT	NBUT	EBRT	EBTH	EBLT	EBUT	TOTAL
700-800	153	0	13	2	24	1427	1	3	0	3	2	0	3	1221	57	0	2909
715-815	166	0	17	0	22	1455	1	4	0	2	3	0	4	1131	57	0	2862
730-830	169	0	21	1	20	1495	1	4	0	1	3	0	3	1047	56	0	2821
745-845	154	1	23	1	18	1434	2	3	1	1	2	0	3	939	63	0	2645
800-900	130	1	20	1	22	1396	2	2	2	0	2	0	4	847	61	0	2490

PEAK HOUR 700-800

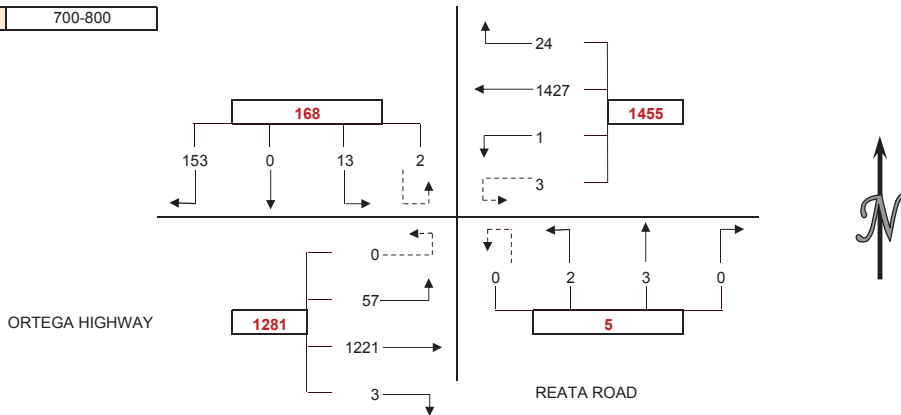

PEDESTRIAN COUNTS

15 MIN COUNTS	NORTH LEG	EAST LEG	SOUTH LEG	WEST LEG	TOTAL
700-715	0	0	0	0	0
715-730	1	0	0	0	1
730-745	1	0	0	0	1
745-800	0	0	0	0	0
800-815	0	3	0	0	3
815-830	0	0	0	0	0
830-845	0	0	0	0	0
845-900	0	0	0	0	0
HOUR TOTALS	NORTH LEG	EAST LEG	SOUTH LEG	WEST LEG	TOTAL
700-800	2	0	0	0	2
715-815	2	3	0	0	5
730-830	1	3	0	0	4
745-845	0	3	0	0	3
800-900	0	3	0	0	3

BICYCLE COUNTS

15 MIN COUNTS	NORTH LEG	EAST LEG	SOUTH LEG	WEST LEG	TOTAL
700-715	0	0	0	0	0
715-730	0	0	0	0	0
730-745	0	0	0	0	0
745-800	0	0	0	0	0
800-815	0	0	0	0	0
815-830	0	1	0	0	1
830-845	1	0	0	0	1
845-900	0	0	0	0	0
HOUR TOTALS	NORTH LEG	EAST LEG	SOUTH LEG	WEST LEG	TOTAL
700-800	0	0	0	0	0
715-815	0	0	0	0	0
730-830	0	1	0	0	1
745-845	1	1	0	0	2
800-900	1	1	0	0	2

APPROACH SUMMARIES

	NORTH APRCH		EAST APRCH		SOUTH APRCH		WEST APRCH	
	APRCH	EXIT	APRCH	EXIT	APRCH	EXIT	APRCH	EXIT
700-800	168	86	1455	1237	5	4	1281	1582
715-815	183	81	1482	1152	5	5	1192	1624
730-830	191	78	1520	1072	4	4	1106	1667
745-845	179	83	1457	966	4	6	1005	1590
800-900	152	84	1422	871	4	7	912	1528

INTERSECTION CAR/PED/BIKE TRAFFIC COUNT RESULTS SUMMARY

CLIENT: LSA
 PROJECT: ORTEGA HIGHWAY (SR-74) - SAN JUAN CAPISTRANO
 DATE: TUESDAY MARCH 27, 2018
 PERIOD: 4:00 PM TO 6:00 PM
 INTERSECTION: N/S REATA ROAD
 E/W ORTEGA HIGHWAY
 CITY: SAN JUAN CAPISTRANO

VEHICLE COUNTS

15 MIN COUNTS	1	2	3	3U	4	5	6	6U	7	8	9	9U	10	11	12	12U	TOTAL
PERIOD	SBRT	SBTH	SBLT	SBUT	WBRT	WBTH	WBLT	WBUT	NBRT	NBTH	NBLT	NBUT	EBRT	EBTH	EBLT	EBUT	TOTAL
400-415	18	0	7	1	4	261	0	3	2	0	0	0	1	413	20	0	730
415-430	11	0	6	0	2	283	0	2	1	0	1	0	0	407	21	0	734
430-445	25	0	6	1	2	239	0	3	1	0	1	0	2	381	21	0	682
445-500	42	0	8	0	6	243	0	2	0	0	0	0	0	324	19	0	644
500-515	32	0	7	0	8	233	0	5	0	0	0	0	0	343	14	0	642
515-530	19	1	4	1	11	300	0	6	0	0	0	0	0	341	25	0	708
530-545	25	0	2	0	7	218	0	4	0	0	0	0	1	381	24	0	662
545-600	17	0	1	0	11	236	0	5	2	0	0	0	1	394	28	0	695
HOUR TOTALS	1	2	3	3U	4	5	6	6U	7	8	9	9U	10	11	12	12U	TOTAL
PERIOD	SBRT	SBTH	SBLT	SBUT	WBRT	WBTH	WBLT	WBUT	NBRT	NBTH	NBLT	NBUT	EBRT	EBTH	EBLT	EBUT	TOTAL
400-500	96	0	27	2	14	1026	0	10	4	0	2	0	3	1525	81	0	2790
415-515	110	0	27	1	18	998	0	12	2	0	2	0	2	1455	75	0	2702
430-530	118	1	25	2	27	1015	0	16	1	0	1	0	2	1389	79	0	2676
445-545	118	1	21	1	32	994	0	17	0	0	0	0	1	1389	82	0	2656
500-600	93	1	14	1	37	987	0	20	2	0	0	0	2	1459	91	0	2707

PEAK HOUR 400-500

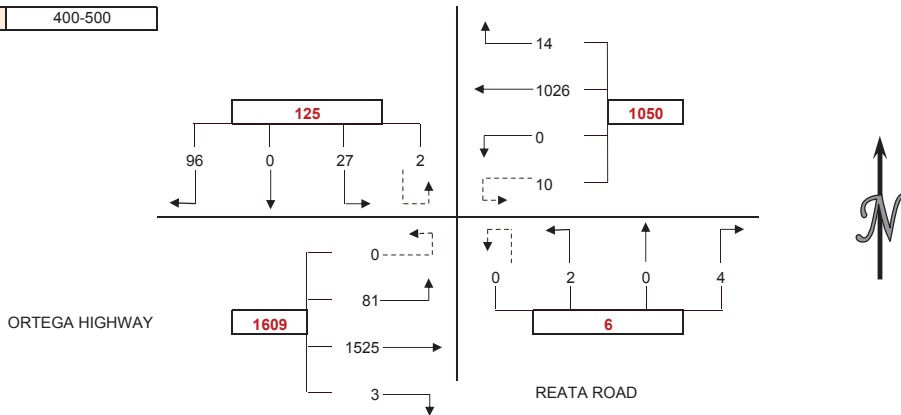

PEDESTRIAN COUNTS

15 MIN COUNTS	NORTH LEG	EAST LEG	SOUTH LEG	WEST LEG	TOTAL
400-415	0	0	0	0	0
415-430	0	0	0	0	0
430-445	0	0	0	0	0
445-500	0	0	0	3	3
500-515	0	0	0	0	0
515-530	0	0	0	0	0
530-545	0	0	0	0	0
545-600	0	0	0	3	3
HOUR TOTALS	NORTH LEG	EAST LEG	SOUTH LEG	WEST LEG	TOTAL
400-500	0	0	0	3	3
415-515	0	0	0	3	3
430-530	0	0	0	3	3
445-545	0	0	0	3	3
500-600	0	0	0	3	3

BICYCLE COUNTS

15 MIN COUNTS	NORTH LEG	EAST LEG	SOUTH LEG	WEST LEG	TOTAL
400-415	0	0	0	0	0
415-430	0	0	0	0	0
430-445	0	1	1	0	2
445-500	0	0	0	0	0
500-515	0	0	0	0	0
515-530	0	0	0	0	0
530-545	0	0	0	0	0
545-600	0	0	0	0	0
HOUR TOTALS	NORTH LEG	EAST LEG	SOUTH LEG	WEST LEG	TOTAL
400-500	0	1	1	0	2
415-515	0	1	1	0	2
430-530	0	1	1	0	2
445-545	0	0	0	0	0
500-600	0	0	0	0	0

APPROACH SUMMARIES

	NORTH APRCH		EAST APRCH		SOUTH APRCH		WEST APRCH	
	APRCH	EXIT	APRCH	EXIT	APRCH	EXIT	APRCH	EXIT
400-500	125	97	1050	1566	6	3	1609	1124
415-515	138	94	1028	1496	4	2	1532	1110
430-530	146	108	1058	1431	2	3	1470	1134
445-545	141	115	1043	1427	0	2	1472	1112
500-600	109	129	1044	1495	2	3	1552	1080

INTERSECTION CAR/PED/BIKE TRAFFIC COUNT RESULTS SUMMARY

CLIENT: LSA
 PROJECT: ORTEGA HIGHWAY (SR-74) - SAN JUAN CAPISTRANO
 DATE: TUESDAY MARCH 27, 2018
 PERIOD: 7:00 AM TO 9:00 AM
 INTERSECTION: N/S ANTONIO PARKWAY / AVENIDA LA PATA
 E/W ORTEGA HIGHWAY
 CITY: SAN JUAN CAPISTRANO

VEHICLE COUNTS

15 MIN COUNTS	1	2	3	3U	4	5	6	6U	7	8	9	9U	10	11	12	12U	TOTAL
PERIOD	SBRT	SBTH	SBLT	SBUT	WBRT	WBTH	WBLT	WBUT	NBRT	NBTH	NBLT	NBUT	EBRT	EBTH	EBLT	EBUT	TOTAL
700-715	136	106	26	0	69	182	36	0	7	57	70	8	48	26	102	0	873
715-730	179	228	17	0	77	193	36	0	7	87	99	9	71	33	120	0	1156
730-745	150	287	28	0	87	162	54	0	7	160	85	5	116	50	103	0	1294
745-800	107	117	38	2	83	166	46	0	11	138	99	9	116	76	161	0	1169
800-815	132	94	32	0	44	133	25	0	15	109	115	7	82	40	103	0	931
815-830	128	105	21	0	56	151	44	0	7	83	81	9	62	48	91	0	886
830-845	132	94	21	0	51	140	22	0	3	58	71	4	68	56	101	1	822
845-900	130	78	26	0	42	181	32	0	9	40	62	3	61	58	125	0	847
HOUR TOTALS	1	2	3	3U	4	5	6	6U	7	8	9	9U	10	11	12	12U	TOTAL
PERIOD	SBRT	SBTH	SBLT	SBUT	WBRT	WBTH	WBLT	WBUT	NBRT	NBTH	NBLT	NBUT	EBRT	EBTH	EBLT	EBUT	TOTAL
700-800	572	738	109	2	316	703	172	0	32	442	353	31	351	185	486	0	4492
715-815	568	726	115	2	291	654	161	0	40	494	398	30	385	199	487	0	4550
730-830	517	603	119	2	270	612	169	0	40	490	380	30	376	214	458	0	4280
745-845	499	410	112	2	234	590	137	0	36	388	366	29	328	220	456	1	3808
800-900	522	371	100	0	193	605	123	0	34	290	329	23	273	202	420	1	3486

PEAK HOUR 715-815

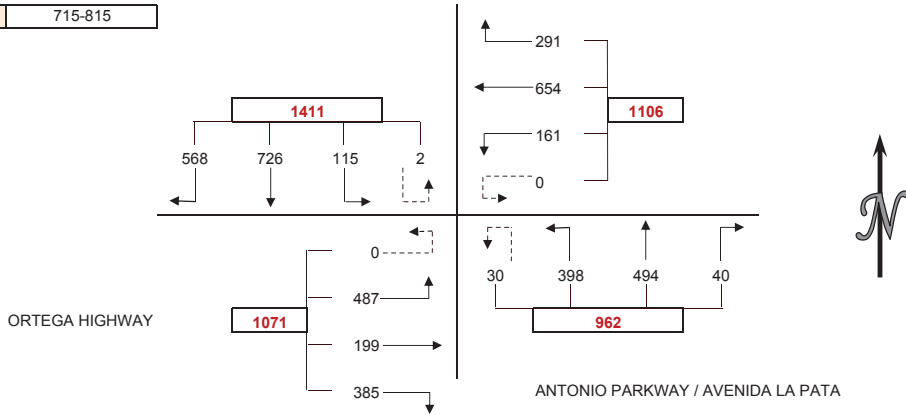

PEDESTRIAN COUNTS

15 MIN COUNTS	NORTH LEG	EAST LEG	SOUTH LEG	WEST LEG	TOTAL
700-715	0	0	0	0	0
715-730	0	0	0	0	0
730-745	0	0	0	0	0
745-800	0	0	0	0	0
800-815	0	0	0	0	0
815-830	0	0	0	0	0
830-845	0	0	0	0	0
845-900	0	0	0	0	0
HOUR TOTALS	NORTH LEG	EAST LEG	SOUTH LEG	WEST LEG	TOTAL
700-800	0	0	0	0	0
715-815	0	0	0	0	0
730-830	0	0	0	0	0
745-845	0	0	0	0	0
800-900	0	0	0	0	0

BICYCLE COUNTS

15 MIN COUNTS	NORTH LEG	EAST LEG	SOUTH LEG	WEST LEG	TOTAL
700-715	0	0	0	0	0
715-730	0	0	0	0	0
730-745	0	0	0	0	0
745-800	0	0	0	0	0
800-815	0	0	0	0	0
815-830	0	0	0	4	4
830-845	0	0	1	0	1
845-900	0	0	0	0	0
HOUR TOTALS	NORTH LEG	EAST LEG	SOUTH LEG	WEST LEG	TOTAL
700-800	0	0	0	0	0
715-815	0	0	0	0	0
730-830	0	0	0	4	4
745-845	0	0	1	4	5
800-900	0	0	1	4	5

APPROACH SUMMARIES

	NORTH APRCH		EAST APRCH		SOUTH APRCH		WEST APRCH	
	APRCH	EXIT	APRCH	EXIT	APRCH	EXIT	APRCH	EXIT
700-800	1421	1246	1191	326	858	1292	1022	1628
715-815	1411	1274	1106	354	962	1302	1071	1620
730-830	1241	1220	1051	373	940	1178	1048	1509
745-845	1023	1080	961	368	819	904	1005	1456
800-900	993	903	921	336	676	790	896	1457

INTERSECTION CAR/PED/BIKE TRAFFIC COUNT RESULTS SUMMARY

CLIENT: LSA
 PROJECT: ORTEGA HIGHWAY (SR-74) - SAN JUAN CAPISTRANO
 DATE: TUESDAY MARCH 27, 2018
 PERIOD: 4:00 PM TO 6:00 PM
 INTERSECTION: N/S ANTONIO PARKWAY / AVENIDA LA PATA
 E/W ORTEGA HIGHWAY
 CITY: SAN JUAN CAPISTRANO

VEHICLE COUNTS

15 MIN COUNTS	1	2	3	3U	4	5	6	6U	7	8	9	9U	10	11	12	12U	TOTAL
PERIOD	SBRT	SBTH	SBLT	SBUT	WBRT	WBTH	WBLT	WBUT	NBRT	NBTH	NBLT	NBUT	EBRT	EBTH	EBLT	EBUT	TOTAL
400-415	151	122	76	2	20	79	18	0	33	126	78	4	69	235	127	0	1140
415-430	145	114	70	0	29	63	16	0	38	131	81	2	50	209	129	0	1077
430-445	104	91	67	0	23	82	27	0	28	122	71	0	57	214	145	0	1031
445-500	129	115	66	1	37	69	12	0	28	149	65	2	47	174	113	0	1007
500-515	123	129	45	0	26	63	11	0	24	145	77	2	43	160	147	0	995
515-530	143	157	68	0	31	52	19	0	34	166	95	4	58	150	120	0	1097
530-545	106	121	54	0	23	65	15	0	21	123	49	3	75	169	169	0	993
545-600	105	135	47	0	26	62	17	0	19	117	80	3	76	150	138	0	975
HOUR TOTALS	1	2	3	3U	4	5	6	6U	7	8	9	9U	10	11	12	12U	TOTAL
PERIOD	SBRT	SBTH	SBLT	SBUT	WBRT	WBTH	WBLT	WBUT	NBRT	NBTH	NBLT	NBUT	EBRT	EBTH	EBLT	EBUT	TOTAL
400-500	529	442	279	3	109	293	73	0	127	528	295	8	223	832	514	0	4255
415-515	501	449	248	1	115	277	66	0	118	547	294	6	197	757	534	0	4110
430-530	499	492	246	1	117	266	69	0	114	582	308	8	205	698	525	0	4130
445-545	501	522	233	1	117	249	57	0	107	583	286	11	223	653	549	0	4092
500-600	477	542	214	0	106	242	62	0	98	551	301	12	252	629	574	0	4060

PEAK HOUR 400-500

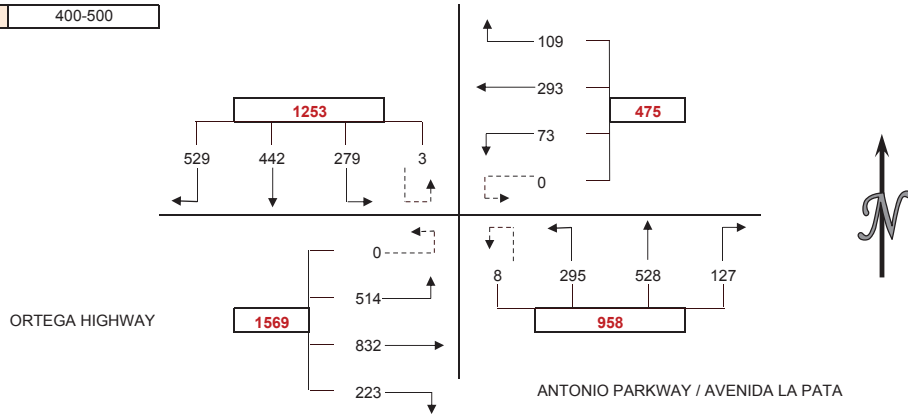

PEDESTRIAN COUNTS

15 MIN COUNTS	NORTH LEG	EAST LEG	SOUTH LEG	WEST LEG	TOTAL
400-415	0	0	0	0	0
415-430	0	0	0	0	0
430-445	0	0	0	0	0
445-500	0	0	0	0	0
500-515	0	0	0	0	0
515-530	0	0	0	1	1
530-545	0	0	0	0	0
545-600	0	0	0	1	1
HOUR TOTALS	NORTH LEG	EAST LEG	SOUTH LEG	WEST LEG	TOTAL
400-500	0	0	0	0	0
415-515	0	0	0	0	0
430-530	0	0	0	1	1
445-545	0	0	0	1	1
500-600	0	0	0	2	2

BICYCLE COUNTS

15 MIN COUNTS	NORTH LEG	EAST LEG	SOUTH LEG	WEST LEG	TOTAL
400-415	0	0	0	0	0
415-430	0	0	0	1	1
430-445	0	0	0	0	0
445-500	0	0	0	1	1
500-515	0	0	0	0	0
515-530	0	0	0	0	0
530-545	0	0	0	0	0
545-600	0	0	0	0	0
HOUR TOTALS	NORTH LEG	EAST LEG	SOUTH LEG	WEST LEG	TOTAL
400-500	0	0	0	2	2
415-515	0	0	0	2	2
430-530	0	0	0	1	1
445-545	0	0	0	1	1
500-600	0	0	0	0	0

APPROACH SUMMARIES

	NORTH APRCH		EAST APRCH		SOUTH APRCH		WEST APRCH	
	APRCH	EXIT	APRCH	EXIT	APRCH	EXIT	APRCH	EXIT
400-500	1253	1154	475	1238	958	746	1569	1117
415-515	1199	1197	458	1123	965	718	1488	1072
430-530	1238	1225	452	1058	1012	774	1428	1073
445-545	1257	1250	423	993	987	813	1425	1036
500-600	1233	1231	410	941	962	868	1455	1020

ITM Peak Hour Summary



Prepared by:
National Data & Surveying Services

La Pata Ave and Vista Montana, San Juan Capistrano

Date: 5/2/2017
Day: Tuesday

Project #: 17-1105-006
City: San Juan Capistrano

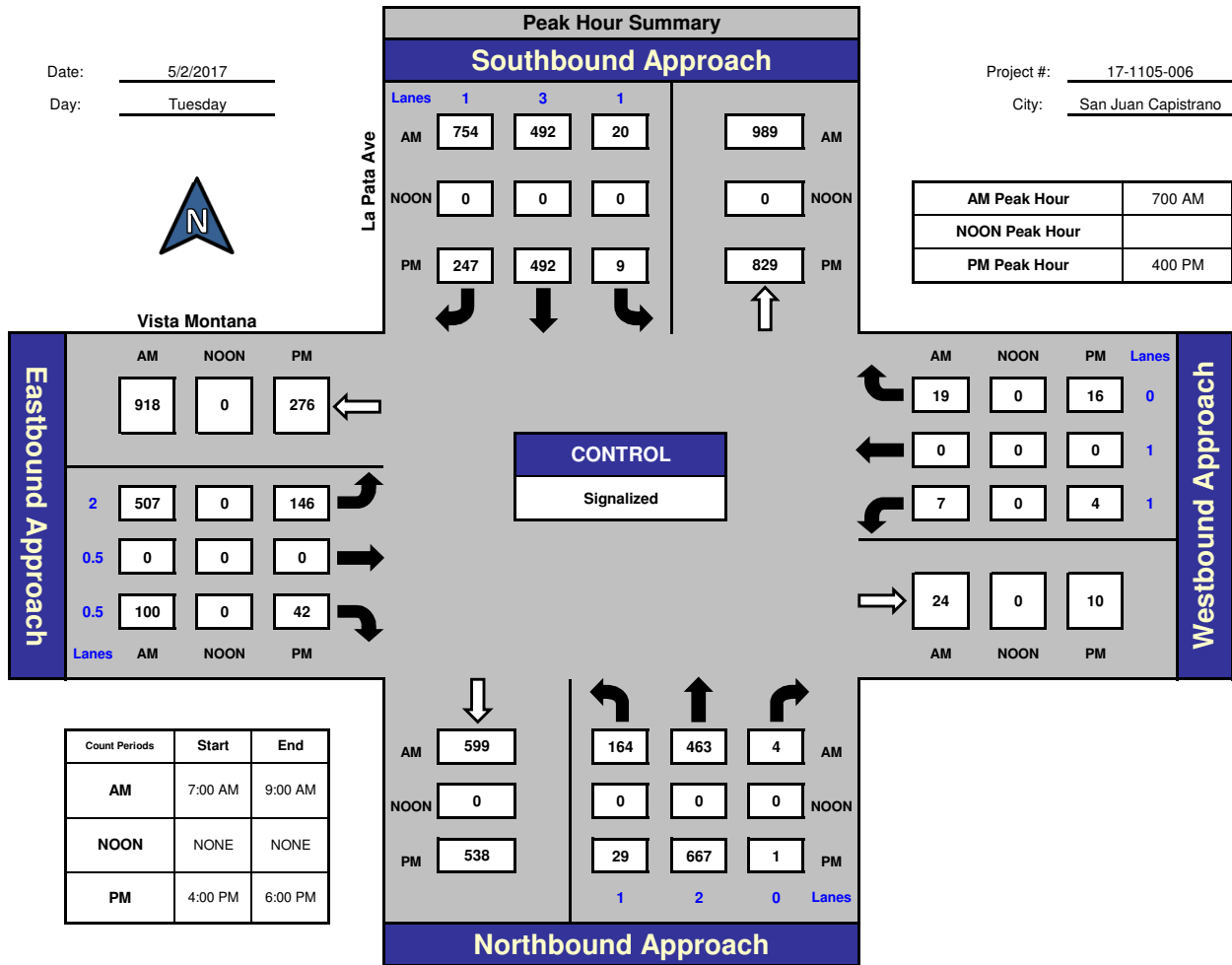

Total Ins & Outs

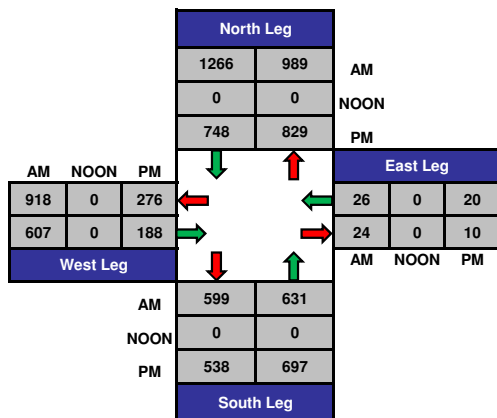

Total Volume Per Leg

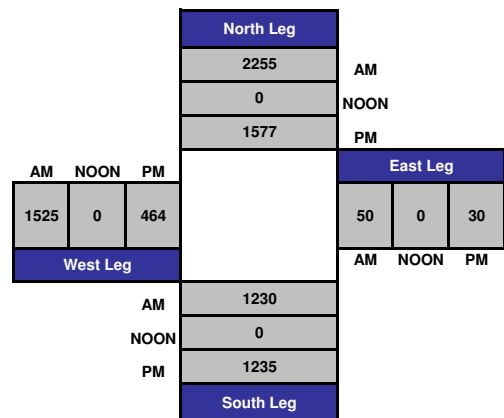

VOLUME

Ortega Hwy Bet. I-5 SB ramps & I-5 NB ramps

Day: Tue - Thu

AVERAGE

City: San Juan Capistrano

Date: 11/13 - 11/15/2018

Project #: CA18_1240_003

DAILY TOTALS						NB	SB					Total
						0	0	28,186	WB		15,282	43,468
AM Period	NB	SB	EB	WB	TOTAL	PM Period	NB	SB	EB	WB	TOTAL	
00:00	0	0	30	15	45	12:00	0	0	466	305	771	
00:15	0	0	23	18	41	12:15	0	0	458	275	733	
00:30	0	0	21	9	30	12:30	0	0	472	311	783	
00:45	0	0	22	96	118	12:45	0	0	476	1872	2348	
01:00	0	0	13	9	22	13:00	0	0	462	294	756	
01:15	0	0	11	9	20	13:15	0	0	519	278	797	
01:30	0	0	15	7	22	13:30	0	0	470	265	735	
01:45	0	0	14	53	67	13:45	0	0	465	1916	2381	
02:00	0	0	12	7	19	14:00	0	0	467	237	704	
02:15	0	0	14	6	20	14:15	0	0	522	264	786	
02:30	0	0	8	6	14	14:30	0	0	556	239	795	
02:45	0	0	13	47	60	14:45	0	0	577	2122	2700	
03:00	0	0	14	5	19	15:00	0	0	516	312	828	
03:15	0	0	17	5	22	15:15	0	0	539	341	880	
03:30	0	0	25	3	28	15:30	0	0	508	306	814	
03:45	0	0	22	78	100	15:45	0	0	543	2106	2649	
04:00	0	0	18	8	26	16:00	0	0	525	294	819	
04:15	0	0	37	7	44	16:15	0	0	508	273	781	
04:30	0	0	63	12	75	16:30	0	0	530	278	808	
04:45	0	0	75	193	268	16:45	0	0	517	2080	2597	
05:00	0	0	94	31	125	17:00	0	0	523	284	807	
05:15	0	0	115	51	166	17:15	0	0	458	292	750	
05:30	0	0	147	49	196	17:30	0	0	487	271	758	
05:45	0	0	207	563	770	17:45	0	0	495	1963	2458	
06:00	0	0	244	82	326	18:00	0	0	435	260	695	
06:15	0	0	317	74	391	18:15	0	0	447	234	681	
06:30	0	0	405	134	539	18:30	0	0	410	227	637	
06:45	0	0	375	1341	1716	18:45	0	0	388	1680	2068	
07:00	0	0	411	211	622	19:00	0	0	357	180	537	
07:15	0	0	420	253	673	19:15	0	0	320	152	472	
07:30	0	0	459	267	726	19:30	0	0	291	123	414	
07:45	0	0	556	1846	2402	19:45	0	0	264	1232	1496	
08:00	0	0	515	214	729	20:00	0	0	244	110	354	
08:15	0	0	434	256	690	20:15	0	0	255	113	368	
08:30	0	0	396	229	625	20:30	0	0	213	105	318	
08:45	0	0	412	1757	2169	20:45	0	0	231	943	1174	
09:00	0	0	398	244	642	21:00	0	0	246	93	339	
09:15	0	0	401	241	642	21:15	0	0	210	74	284	
09:30	0	0	376	242	618	21:30	0	0	176	62	238	
09:45	0	0	378	1553	1931	21:45	0	0	132	764	896	
10:00	0	0	369	243	612	22:00	0	0	133	57	190	
10:15	0	0	406	256	662	22:15	0	0	100	35	135	
10:30	0	0	415	246	661	22:30	0	0	86	39	125	
10:45	0	0	426	1616	2042	22:45	0	0	85	404	489	
11:00	0	0	408	268	676	23:00	0	0	58	27	85	
11:15	0	0	436	292	728	23:15	0	0	50	29	79	
11:30	0	0	461	301	762	23:30	0	0	47	34	81	
11:45	0	0	465	1770	2235	23:45	0	0	36	191	227	
TOTALS			10913	5950	16863	TOTALS			17273	9332	26605	
SPLIT %			64.7%	35.3%	38.8%	SPLIT %			64.9%	35.1%	61.2%	

DAILY TOTALS						NB	SB					Total
						0	0	28,186	WB		15,282	43,468

AM Peak Hour		07:30	11:15	11:45	PM Peak Hour		14:30	14:45	14:45		
AM Pk Volume		1964	1224	3078	PM Pk Volume		2188	1285	3473		
Pk Hr Factor		0.883	0.939	0.973	Pk Hr Factor		0.948	0.942	0.948		
7 - 9 Volume	0	0	3603	1865	5468	4 - 6 Volume	0	0	4043	2213	6256
7 - 9 Peak Hour		07:30	07:30	07:30	4 - 6 Peak Hour		16:00	16:30	16:00		
7 - 9 Pk Volume	0	0	1964	948	2912	4 - 6 Pk Volume	0	0	2080	1126	3206
Pk Hr Factor	0.000	0.000	0.883	0.888	0.949	Pk Hr Factor	0.000	0.000	0.981	0.964	0.976

VOLUME

Ortega Hwy Bet. I-5 NB ramps & Rancho Viejo Rd

Day: Tue - Thu

AVERAGE

City: San Juan Capistrano

Date: 11/13 - 11/15/2018

Project #: CA18_1240_004

DAILY TOTALS						NB	SB	EB	WB	Total					
						0	0	25,149	24,437	49,586					
AM Period	NB	SB	EB	WB	TOTAL	PM Period	NB	SB	EB	WB	TOTAL				
00:00	0	0	24	20	44	12:00	0	0	386	382	768				
00:15	0	0	24	17	41	12:15	0	0	388	374	762				
00:30	0	0	16	15	31	12:30	0	0	398	399	797				
00:45	0	0	18	82	8	60	12:45	0	0	407	1579	417	1572	824	3151
01:00	0	0	14	14	28	13:00	0	0	389	411	800				
01:15	0	0	13	11	24	13:15	0	0	394	399	793				
01:30	0	0	12	11	23	13:30	0	0	408	349	757				
01:45	0	0	12	51	13	49	13:45	0	0	415	1606	348	1507	763	3113
02:00	0	0	8	9	17	14:00	0	0	396	402	798				
02:15	0	0	12	6	18	14:15	0	0	459	379	838				
02:30	0	0	8	10	18	14:30	0	0	467	373	840				
02:45	0	0	13	41	9	34	14:45	0	0	527	1849	417	1571	944	3420
03:00	0	0	11	12	23	15:00	0	0	520	456	976				
03:15	0	0	16	14	30	15:15	0	0	487	497	984				
03:30	0	0	18	18	36	15:30	0	0	531	509	1040				
03:45	0	0	20	65	25	69	15:45	0	0	498	2036	448	1910	946	3946
04:00	0	0	17	31	48	16:00	0	0	502	456	958				
04:15	0	0	33	38	71	16:15	0	0	472	442	914				
04:30	0	0	52	67	119	16:30	0	0	480	471	951				
04:45	0	0	66	168	98	234	16:45	0	0	481	1935	450	1819	931	3754
05:00	0	0	74	123	197	17:00	0	0	436	460	896				
05:15	0	0	106	190	296	17:15	0	0	443	455	898				
05:30	0	0	138	239	377	17:30	0	0	435	418	853				
05:45	0	0	197	515	281	833	17:45	0	0	478	1792	362	1695	840	3487
06:00	0	0	222	281	503	18:00	0	0	435	334	769				
06:15	0	0	316	308	624	18:15	0	0	433	303	736				
06:30	0	0	392	380	772	18:30	0	0	385	290	675				
06:45	0	0	368	1298	435	1404	18:45	0	0	339	1592	240	1167	579	2759
07:00	0	0	363	430	793	19:00	0	0	319	209	528				
07:15	0	0	399	470	869	19:15	0	0	287	208	495				
07:30	0	0	401	465	866	19:30	0	0	262	188	450				
07:45	0	0	536	1699	449	1814	19:45	0	0	226	1094	167	772	393	1866
08:00	0	0	529	456	985	20:00	0	0	205	156	361				
08:15	0	0	414	466	880	20:15	0	0	207	141	348				
08:30	0	0	358	483	841	20:30	0	0	195	137	332				
08:45	0	0	400	1701	425	1830	20:45	0	0	190	797	137	571	327	1368
09:00	0	0	364	421	785	21:00	0	0	180	132	312				
09:15	0	0	339	434	773	21:15	0	0	166	99	265				
09:30	0	0	327	393	720	21:30	0	0	130	101	231				
09:45	0	0	318	1348	401	1649	21:45	0	0	104	580	85	417	189	997
10:00	0	0	321	398	719	22:00	0	0	103	77	180				
10:15	0	0	337	395	732	22:15	0	0	87	58	145				
10:30	0	0	339	376	715	22:30	0	0	71	58	129				
10:45	0	0	335	1332	373	1542	22:45	0	0	72	333	53	246	125	579
11:00	0	0	356	370	726	23:00	0	0	56	39	95				
11:15	0	0	375	383	758	23:15	0	0	42	37	79				
11:30	0	0	378	384	762	23:30	0	0	42	35	77				
11:45	0	0	374	1483	398	1535	23:45	0	0	33	173	26	137	59	310
TOTALS			9783	11053	20836	TOTALS			15366	13384	28750				
SPLIT %			47.0%	53.0%	42.0%	SPLIT %			53.4%	46.6%	58.0%				

DAILY TOTALS						NB	SB	EB	WB	Total
						0	0	25,149	24,437	49,586

AM Peak Hour	07:30	07:45	07:30	PM Peak Hour	14:45	15:00	15:00				
AM Pk Volume	1880	1854	3716	PM Pk Volume	2065	1910	3946				
Pk Hr Factor	0.877	0.960	0.943	Pk Hr Factor	0.972	0.938	0.949				
7 - 9 Volume	0	0	3400	3644	7044	4 - 6 Volume	0	0	3727	3514	7241
7 - 9 Peak Hour	07:30	07:45	07:30	4 - 6 Peak Hour	16:00	16:30	16:00				
7 - 9 Pk Volume	0	0	1880	1854	3716	4 - 6 Pk Volume	0	0	1935	1836	3754
Pk Hr Factor	0.000	0.000	0.877	0.960	0.943	Pk Hr Factor	0.000	0.000	0.964	0.975	0.980

VOLUME

Ortega Hwy Bet. Rancho Viejo Rd & La Novia Ave

Day: Tue - Thu

AVERAGE

City: San Juan Capistrano

Date: 11/13 - 11/15/2018

Project #: CA18_1240_005

DAILY TOTALS					NB	SB	EB	WB	Total
					0	0	20,889	21,521	42,410

AM Period	NB	SB	EB	WB	TOTAL	PM Period	NB	SB	EB	WB	TOTAL				
00:00	0	0	20	13	33	12:00	0	0	303	325	628				
00:15	0	0	20	14	34	12:15	0	0	299	334	633				
00:30	0	0	13	12	25	12:30	0	0	306	351	657				
00:45	0	0	16	69	7	46	12:45	0	0	333	1241	367	1377	700	2618
01:00	0	0	12	11	23	13:00	0	0	304	330	634				
01:15	0	0	11	8	19	13:15	0	0	312	329	641				
01:30	0	0	11	9	20	13:30	0	0	340	303	643				
01:45	0	0	10	44	11	39	13:45	0	0	321	1277	309	1271	630	2548
02:00	0	0	9	6	15	14:00	0	0	335	315	650				
02:15	0	0	10	6	16	14:15	0	0	367	321	688				
02:30	0	0	9	10	19	14:30	0	0	414	338	752				
02:45	0	0	12	40	8	30	14:45	0	0	434	1550	372	1346	806	2896
03:00	0	0	12	10	22	15:00	0	0	475	413	888				
03:15	0	0	14	13	27	15:15	0	0	437	482	919				
03:30	0	0	14	15	29	15:30	0	0	464	442	906				
03:45	0	0	17	57	20	58	15:45	0	0	428	1804	383	1720	811	3524
04:00	0	0	12	29	41	16:00	0	0	454	326	780				
04:15	0	0	27	32	59	16:15	0	0	431	357	788				
04:30	0	0	47	68	115	16:30	0	0	451	336	787				
04:45	0	0	50	136	96	225	16:45	0	0	425	1761	352	1371	777	3132
05:00	0	0	54	119	173	17:00	0	0	400	337	737				
05:15	0	0	74	186	260	17:15	0	0	390	340	730				
05:30	0	0	115	242	357	17:30	0	0	417	296	713				
05:45	0	0	156	399	285	832	17:45	0	0	403	1610	272	1245	675	2855
06:00	0	0	192	266	458	18:00	0	0	392	237	629				
06:15	0	0	290	308	598	18:15	0	0	399	228	627				
06:30	0	0	365	389	754	18:30	0	0	366	203	569				
06:45	0	0	314	1161	458	1421	18:45	0	0	302	1459	174	842	476	2301
07:00	0	0	301	431	732	19:00	0	0	295	138	433				
07:15	0	0	343	489	832	19:15	0	0	270	148	418				
07:30	0	0	323	518	841	19:30	0	0	236	120	356				
07:45	0	0	335	1302	469	1907	19:45	0	0	204	1005	104	510	308	1515
08:00	0	0	329	507	836	20:00	0	0	190	98	288				
08:15	0	0	296	528	824	20:15	0	0	194	97	291				
08:30	0	0	261	517	778	20:30	0	0	184	94	278				
08:45	0	0	224	1110	433	1985	20:45	0	0	175	743	98	387	273	1130
09:00	0	0	249	406	655	21:00	0	0	164	85	249				
09:15	0	0	240	413	653	21:15	0	0	152	73	225				
09:30	0	0	256	364	620	21:30	0	0	123	72	195				
09:45	0	0	230	975	421	1604	21:45	0	0	94	533	57	287	151	820
10:00	0	0	231	373	604	22:00	0	0	89	54	143				
10:15	0	0	257	366	623	22:15	0	0	78	39	117				
10:30	0	0	261	336	597	22:30	0	0	68	41	109				
10:45	0	0	258	1007	354	1429	22:45	0	0	62	297	35	169	97	466
11:00	0	0	271	327	598	23:00	0	0	50	30	80				
11:15	0	0	298	335	633	23:15	0	0	37	31	68				
11:30	0	0	299	319	618	23:30	0	0	39	21	60				
11:45	0	0	282	1150	338	1319	23:45	0	0	33	159	19	101	52	260
TOTALS			7450	10895	18345	TOTALS			13439	10626	24065				
SPLIT %			40.6%	59.4%	43.3%	SPLIT %			55.8%	44.2%	56.7%				

DAILY TOTALS					NB	SB	EB	WB	Total
					0	0	20,889	21,521	42,410

AM Peak Hour		07:15	07:30	07:15	PM Peak Hour		14:45	15:00	15:00		
AM Pk Volume		1330	2022	3313	PM Pk Volume		1810	1720	3524		
Pk Hr Factor		0.969	0.957	0.985	Pk Hr Factor		0.953	0.892	0.959		
7 - 9 Volume	0	0	2412	3892	6304	4 - 6 Volume	0	0	3371	2616	5987
7 - 9 Peak Hour		07:15	07:30	07:15	4 - 6 Peak Hour		16:00	16:15	16:00	16:00	
7 - 9 Pk Volume	0	0	1330	2022	3313	4 - 6 Pk Volume	0	0	1761	1382	3132
Pk Hr Factor	0.000	0.000	0.969	0.957	0.985	Pk Hr Factor	0.000	0.000	0.970	0.968	0.994

WILTEC

Phone: (626) 564-1944 Fax: (626) 564-0969

24-HOUR ADT COUNT SUMMARY

CLIENT: LSA
 PROJECT: ORTEGA HIGHWAY (SR-74) - SAN JUAN CAPISTRANO
 LOCATION: ORTEGA HIGHWAY BETWEEN VIA CORDOVA AND VIA CRISTAL
 SAN JUAN CAPISTRANO
 DATE: TUESDAY MARCH 27, 2018

DIRECTION:		EB				HOUR TOTALS
TIME	00-15	15-30	30-45	45-60		
0:00	16	15	13	15	59	
1:00	5	6	7	6	24	
2:00	4	6	8	6	24	
3:00	6	10	12	18	46	
4:00	17	21	21	43	102	
5:00	49	70	99	169	387	
6:00	171	273	367	368	1179	
7:00	294	323	343	331	1291	
8:00	217	225	260	228	930	
9:00	189	210	202	199	800	
10:00	201	215	189	198	803	
11:00	201	203	226	241	871	
12:00	227	246	260	276	1009	
13:00	300	255	271	301	1127	
14:00	278	315	307	373	1273	
15:00	390	364	399	400	1553	
16:00	414	422	403	329	1568	
17:00	360	384	388	429	1561	
18:00	399	367	370	295	1431	
19:00	274	242	260	207	983	
20:00	191	188	200	168	747	
21:00	143	151	118	85	497	
22:00	89	78	57	50	274	
23:00	48	49	27	25	149	
				TOTAL	18688	
AM PEAK HOUR		0630-0730				
VOLUME		1352				
PM PEAK HOUR		1545-1645				
VOLUME		1639				

DIRECTION:		WB				HOUR TOTALS
TIME	00-15	15-30	30-45	45-60		
0:00	15	6	12	7	40	
1:00	6	9	2	6	23	
2:00	5	7	6	7	25	
3:00	6	7	9	17	39	
4:00	21	25	45	88	179	
5:00	79	138	227	246	690	
6:00	262	238	270	334	1104	
7:00	380	390	411	398	1579	
8:00	389	441	397	364	1591	
9:00	335	310	294	295	1234	
10:00	233	253	226	260	972	
11:00	261	233	221	268	983	
12:00	203	257	265	301	1026	
13:00	243	248	244	243	978	
14:00	236	273	272	313	1094	
15:00	353	360	363	355	1431	
16:00	265	273	290	268	1096	
17:00	244	307	279	249	1079	
18:00	229	209	232	234	904	
19:00	215	152	160	124	651	
20:00	130	118	115	82	445	
21:00	86	117	57	48	308	
22:00	42	43	41	35	161	
23:00	24	27	28	22	101	
				TOTAL	17733	
AM PEAK HOUR		0730-0830				
VOLUME		1639				
PM PEAK HOUR		1500-1600				
VOLUME		1431				

TOTAL BI-DIRECTIONAL VOLUME	36421
-----------------------------	-------

WILTEC

Phone: (626) 564-1944 Fax: (626) 564-0969

24-HOUR ADT COUNT SUMMARY

CLIENT: LSA
 PROJECT: ORTEGA HIGHWAY (SR-74) - SAN JUAN CAPISTRANO
 LOCATION: ORTEGA HIGHWAY BETWEEN VIA ERRECARTE AND SHADETREE LANE / AVENID/
 SAN JUAN CAPISTRANO
 DATE: TUESDAY MARCH 27, 2018

DIRECTION:		EB				HOUR TOTALS
TIME	00-15	15-30	30-45	45-60		
0:00	16	14	14	18	62	
1:00	5	6	7	5	23	
2:00	5	4	9	6	24	
3:00	5	11	9	20	45	
4:00	20	16	24	44	104	
5:00	45	71	95	173	384	
6:00	152	258	379	373	1162	
7:00	298	319	339	321	1277	
8:00	223	223	250	226	922	
9:00	199	196	195	196	786	
10:00	207	207	192	190	796	
11:00	193	191	213	248	845	
12:00	219	226	251	268	964	
13:00	288	241	266	290	1085	
14:00	281	311	283	379	1254	
15:00	371	383	403	395	1552	
16:00	413	420	389	340	1562	
17:00	350	360	400	412	1522	
18:00	402	365	369	283	1419	
19:00	272	239	249	208	968	
20:00	181	168	204	165	718	
21:00	143	152	117	77	489	
22:00	80	82	56	50	268	
23:00	46	45	25	26	142	
				TOTAL	18373	
AM PEAK HOUR		0630-0730				
VOLUME		1369				
PM PEAK HOUR		1530-1630				
VOLUME		1631				

DIRECTION:		WB				HOUR TOTALS
TIME	00-15	15-30	30-45	45-60		
0:00	13	13	8	7	41	
1:00	7	3	4	7	21	
2:00	5	5	5	9	24	
3:00	5	8	12	19	44	
4:00	23	32	53	98	206	
5:00	109	159	255	228	751	
6:00	261	244	291	354	1150	
7:00	386	411	399	376	1572	
8:00	421	431	363	392	1607	
9:00	270	321	265	242	1098	
10:00	239	256	265	254	1014	
11:00	247	223	213	252	935	
12:00	225	240	312	269	1046	
13:00	237	248	232	254	971	
14:00	245	258	301	317	1121	
15:00	391	339	387	314	1431	
16:00	268	271	291	269	1099	
17:00	247	325	239	245	1056	
18:00	244	206	226	226	902	
19:00	180	163	135	137	615	
20:00	116	118	103	82	419	
21:00	105	79	52	38	274	
22:00	30	37	33	25	125	
23:00	15	29	17	12	73	
				TOTAL	17595	
AM PEAK HOUR		0730-0830				
VOLUME		1627				
PM PEAK HOUR		1445-1545				
VOLUME		1434				

TOTAL BI-DIRECTIONAL VOLUME	35968
-----------------------------	-------

APPENDIX B

ICU WORKSHEETS

Impact Analysis Report
Level Of Service

Intersection	Base		Future		Change in
	LOS	Del/ Veh C	LOS	Del/ Veh C	
# 1 I-5 SB Ramps/Ortega	B	xxxxxx 0.644	B	xxxxxx 0.644	+ 0.000 V/C
# 2 I- NB Ramps/Ortega	C	xxxxxx 0.718	C	xxxxxx 0.718	+ 0.000 V/C
# 3 Rancho Viejo/Ortega	B	xxxxxx 0.650	B	xxxxxx 0.650	+ 0.000 V/C
# 4 La Novia/Ortega	B	xxxxxx 0.640	B	xxxxxx 0.640	+ 0.000 V/C
# 5 Reata/Ortega	A	xxxxxx 0.594	A	xxxxxx 0.594	+ 0.000 V/C
# 6 Av. La Pata/Ortega	B	xxxxxx 0.654	B	xxxxxx 0.654	+ 0.000 V/C
# 7 Av. La Pata/Stallion	A	xxxxxx 0.424	A	xxxxxx 0.424	+ 0.000 V/C

Level Of Service Computation Report

ICU 1(Loss as Cycle Length %) Method (Base Volume Alternative)

Intersection #1 I-5 SB Ramps/Ortega

Cycle (sec):	100	Critical Vol./Cap.(X):	0.644
Loss Time (sec):	5	Average Delay (sec/veh):	xxxxxx
Optimal Cycle:	32	Level Of Service:	B

Approach:	North Bound	South Bound	East Bound	West Bound
Movement:	L - T - R	L - T - R	L - T - R	L - T - R

-----|-----|-----|-----|-----|

Control:	Split Phase	Split Phase	Protected	Protected
Rights:	Include	Include	Ignore	Include

Min. Green:	0	0	0	0	0	0	0	0	0	0	0
-------------	---	---	---	---	---	---	---	---	---	---	---

Y+R:	4.0	4.0	4.0	4.0	4.0	4.0	4.0	4.0	4.0	4.0	4.0
------	-----	-----	-----	-----	-----	-----	-----	-----	-----	-----	-----

Lanes:	0	0	0	0	0	2	0	0	0	2	0	0	3	0	1	2	0	2	0	0
--------	---	---	---	---	---	---	---	---	---	---	---	---	---	---	---	---	---	---	---	---

-----|-----|-----|-----|-----|

Volume Module:

Base Vol:	0	0	0	868	0	936	0	1162	194	308	652	0
Growth Adj:	1.00	1.00	1.00	1.00	1.00	1.00	1.00	1.00	1.00	1.00	1.00	1.00
Initial Bse:	0	0	0	868	0	936	0	1162	194	308	652	0
User Adj:	1.00	1.00	1.00	1.00	1.00	1.00	1.00	1.00	0.00	1.00	1.00	1.00
PHF Adj:	1.00	1.00	1.00	1.00	1.00	1.00	1.00	1.00	0.00	1.00	1.00	1.00
PHF Volume:	0	0	0	868	0	936	0	1162	0	308	652	0
Reduct Vol:	0	0	0	0	0	0	0	0	0	0	0	0
Reduced Vol:	0	0	0	868	0	936	0	1162	0	308	652	0
PCE Adj:	1.00	1.00	1.00	1.00	1.00	1.00	1.00	1.00	0.00	1.00	1.00	1.00
MLF Adj:	1.00	1.00	1.00	1.00	1.00	1.00	1.00	1.00	0.00	1.00	1.00	1.00
FinalVolume:	0	0	0	868	0	936	0	1162	0	308	652	0

-----|-----|-----|-----|-----|

Saturation Flow Module:

Sat/Lane:	1700	1700	1700	1700	1700	1700	1700	1700	1700	1700	1700	1700
Adjustment:	1.00	1.00	1.00	1.00	1.00	1.00	1.00	1.00	1.00	1.00	1.00	1.00
Lanes:	0.00	0.00	0.00	2.00	0.00	2.00	0.00	3.00	1.00	2.00	2.00	0.00
Final Sat.:	0	0	0	3400	0	3400	0	5100	1700	3400	3400	0

-----|-----|-----|-----|-----|

Capacity Analysis Module:

Vol/Sat:	0.00	0.00	0.00	0.26	0.00	0.28	0.00	0.23	0.00	0.09	0.19	0.00
Crit Moves:				****		****		****		****		

 Level Of Service Computation Report
 ICU 1(Loss as Cycle Length %) Method (Base Volume Alternative)

Intersection #2 I- NB Ramps/Ortega

Cycle (sec): 100 Critical Vol./Cap.(X): 0.718
 Loss Time (sec): 5 Average Delay (sec/veh): xxxxxx
 Optimal Cycle: 39 Level Of Service: C

Approach:	North Bound			South Bound			East Bound			West Bound		
Movement:	L	T	R	L	T	R	L	T	R	L	T	R
Control:	Split Phase			Split Phase			Protected			Protected		
Rights:	Include			Include			Include			Include		
Min. Green:	0	0	0	0	0	0	0	0	0	0	0	0
Y+R:	4.0	4.0	4.0	4.0	4.0	4.0	4.0	4.0	4.0	4.0	4.0	4.0
Lanes:	0	0	1	1	0	0	1	0	2	1	1	0

Volume Module:

Base Vol:	144	26	678	28	0	98	34	1452	622	0	1680	58
Growth Adj:	1.00	1.00	1.00	1.00	1.00	1.00	1.00	1.00	1.00	1.00	1.00	1.00
Initial Bse:	144	26	678	28	0	98	34	1452	622	0	1680	58
User Adj:	1.00	1.00	1.00	1.00	1.00	1.00	1.00	1.00	1.00	1.00	1.00	1.00
PHF Adj:	1.00	1.00	1.00	1.00	1.00	1.00	1.00	1.00	1.00	1.00	1.00	1.00
PHF Volume:	144	26	678	28	0	98	34	1452	622	0	1680	58
Reduct Vol:	0	0	0	0	0	0	0	0	0	0	0	0
Reduced Vol:	144	26	678	28	0	98	34	1452	622	0	1680	58
PCE Adj:	1.00	1.00	1.00	1.00	1.00	1.00	1.00	1.00	1.00	1.00	1.00	1.00
MLF Adj:	1.00	1.00	1.00	1.00	1.00	1.00	1.00	1.00	1.00	1.00	1.00	1.00
FinalVolume:	144	26	678	28	0	98	34	1452	622	0	1680	58

Saturation Flow Module:

Sat/Lane:	1700	1700	1700	1700	1700	1700	1700	1700	1700	1700	1700	1700
Adjustment:	1.00	1.00	1.00	1.00	1.00	1.00	1.00	1.00	1.00	1.00	1.00	1.00
Lanes:	0.34	0.06	1.60	1.00	0.00	1.00	1.00	2.80	1.20	0.00	2.90	0.10
Final Sat.:	577	104	2718	1700	0	1700	1700	4761	2039	0	4930	170

Capacity Analysis Module:

Vol/Sat:	0.25	0.25	0.25	0.02	0.00	0.06	0.02	0.30	0.31	0.00	0.34	0.34
Crit Moves:	****			****			****			****		

```

-----
Level Of Service Computation Report
ICU 1(Loss as Cycle Length %) Method (Base Volume Alternative)
*****
Intersection #3 Rancho Viejo/Ortega
*****
Cycle (sec):          100          Critical Vol./Cap.(X):          0.650
Loss Time (sec):      5           Average Delay (sec/veh):        xxxxxxx
Optimal Cycle:        33          Level Of Service:                B
*****
Approach:             North Bound      South Bound      East Bound      West Bound
Movement:             L - T - R      L - T - R      L - T - R      L - T - R
-----|-----|-----|-----|
Control:               Split Phase    Split Phase      Protected      Protected
Rights:                Include        Include          Ovl            Include
Min. Green:            0 0 0          0 0 0           0 0 0          0 0 0 0
Y+R:                   4.0 4.0 4.0    4.0 4.0 4.0    4.0 4.0 4.0    4.0 4.0 4.0
Lanes:                 1 1 0 1 0      1 1 0 1 0      1 0 2 0 1      1 0 3 0 1
-----|-----|-----|-----|
Volume Module:
Base Vol:              269 134 58      166 124 109    236 1061 567    71 1489 419
Growth Adj:            1.00 1.00 1.00  1.00 1.00 1.00  1.00 1.00 1.00  1.00 1.00 1.00
Initial Bse:           269 134 58      166 124 109    236 1061 567    71 1489 419
User Adj:              1.00 1.00 1.00  1.00 1.00 1.00  1.00 1.00 1.00  1.00 1.00 1.00
PHF Adj:               1.00 1.00 1.00  1.00 1.00 1.00  1.00 1.00 1.00  1.00 1.00 1.00
PHF Volume:            269 134 58      166 124 109    236 1061 567    71 1489 419
Reduct Vol:            0 0 0           0 0 0           0 0 0           0 0 0
Reduced Vol:           269 134 58      166 124 109    236 1061 567    71 1489 419
PCE Adj:               1.00 1.00 1.00  1.00 1.00 1.00  1.00 1.00 1.00  1.00 1.00 1.00
MLF Adj:               1.00 1.00 1.00  1.00 1.00 1.00  1.00 1.00 1.00  1.00 1.00 1.00
FinalVolume:           269 134 58      166 124 109    236 1061 567    71 1489 419
OvlAdjVol:                                     413
-----|-----|-----|-----|
Saturation Flow Module:
Sat/Lane:              1700 1700 1700  1700 1700 1700  1700 1700 1700  1700 1700 1700
Adjustment:            1.00 1.00 1.00  1.00 1.00 1.00  1.00 1.00 1.00  1.00 1.00 1.00
Lanes:                 1.75 0.87 0.38  1.26 0.93 0.81  1.00 2.00 1.00  1.00 3.00 1.00
Final Sat.:           2984 1478 638  2128 1587 1385  1700 3400 1700  1700 5100 1700
-----|-----|-----|-----|
Capacity Analysis Module:
Vol/Sat:               0.09 0.09 0.09  0.08 0.08 0.08  0.14 0.31 0.33  0.04 0.29 0.25
OvlAdjV/S:                                     0.24
Crit Moves:                ****                ****  ****                ****
*****

```

 Level Of Service Computation Report
 ICU 1(Loss as Cycle Length %) Method (Base Volume Alternative)

Intersection #4 La Novia/Ortega

Cycle (sec): 100 Critical Vol./Cap.(X): 0.640
 Loss Time (sec): 5 Average Delay (sec/veh): xxxxxx
 Optimal Cycle: 32 Level Of Service: B

Approach:	North Bound				South Bound				East Bound				West Bound							
Movement:	L	-	T	-	R	L	-	T	-	R	L	-	T	-	R	L	-	T	-	R
Control:	Protected				Protected				Protected				Protected							
Rights:	Include				Include				Include				Include							
Min. Green:	0	0	0	0	0	0	0	0	0	0	0	0	0	0	0	0	0	0	0	0
Y+R:	4.0	4.0	4.0	4.0	4.0	4.0	4.0	4.0	4.0	4.0	4.0	4.0	4.0	4.0	4.0	4.0	4.0	4.0	4.0	4.0
Lanes:	2	0	0	0	1	0	0	0	0	0	0	0	2	0	1	1	0	2	0	0

Volume Module:

Base Vol:	396	0	230	0	0	0	0	1015	238	208	1546	0
Growth Adj:	1.00	1.00	1.00	1.00	1.00	1.00	1.00	1.00	1.00	1.00	1.00	1.00
Initial Bse:	396	0	230	0	0	0	0	1015	238	208	1546	0
User Adj:	1.00	1.00	1.00	1.00	1.00	1.00	1.00	1.00	1.00	1.00	1.00	1.00
PHF Adj:	1.00	1.00	1.00	1.00	1.00	1.00	1.00	1.00	1.00	1.00	1.00	1.00
PHF Volume:	396	0	230	0	0	0	0	1015	238	208	1546	0
Reduct Vol:	0	0	0	0	0	0	0	0	0	0	0	0
Reduced Vol:	396	0	230	0	0	0	0	1015	238	208	1546	0
PCE Adj:	1.00	1.00	1.00	1.00	1.00	1.00	1.00	1.00	1.00	1.00	1.00	1.00
MLF Adj:	1.00	1.00	1.00	1.00	1.00	1.00	1.00	1.00	1.00	1.00	1.00	1.00
FinalVolume:	396	0	230	0	0	0	0	1015	238	208	1546	0

Saturation Flow Module:

Sat/Lane:	1700	1700	1700	1700	1700	1700	1700	1700	1700	1700	1700	1700
Adjustment:	1.00	1.00	1.00	1.00	1.00	1.00	1.00	1.00	1.00	1.00	1.00	1.00
Lanes:	2.00	0.00	1.00	0.00	0.00	0.00	0.00	2.00	1.00	1.00	2.00	0.00
Final Sat.:	3400	0	1700	0	0	0	0	3400	1700	1700	3400	0

Capacity Analysis Module:

Vol/Sat:	0.12	0.00	0.14	0.00	0.00	0.00	0.00	0.30	0.14	0.12	0.45	0.00
Crit Moves:	****			****				****				

 Level Of Service Computation Report
 ICU 1(Loss as Cycle Length %) Method (Base Volume Alternative)

 Intersection #5 Reata/Ortega

Cycle (sec): 100 Critical Vol./Cap.(X): 0.594
 Loss Time (sec): 5 Average Delay (sec/veh): xxxxxx
 Optimal Cycle: 29 Level Of Service: A

Approach:	North Bound			South Bound			East Bound			West Bound		
Movement:	L	T	R	L	T	R	L	T	R	L	T	R
Control:	Permitted			Permitted			Protected			Protected		
Rights:	Include			Include			Include			Include		
Min. Green:	0	0	0	0	0	0	0	0	0	0	0	0
Y+R:	4.0	4.0	4.0	4.0	4.0	4.0	4.0	4.0	4.0	4.0	4.0	4.0
Lanes:	1	0	0	1	0	0	1	0	2	1	0	2

Volume Module:

Base Vol:	2	3	0	15	0	153	57	1221	3	4	1427	24
Growth Adj:	1.00	1.00	1.00	1.00	1.00	1.00	1.00	1.00	1.00	1.00	1.00	1.00
Initial Bse:	2	3	0	15	0	153	57	1221	3	4	1427	24
User Adj:	1.00	1.00	1.00	1.00	1.00	1.00	1.00	1.00	1.00	1.00	1.00	1.00
PHF Adj:	1.00	1.00	1.00	1.00	1.00	1.00	1.00	1.00	1.00	1.00	1.00	1.00
PHF Volume:	2	3	0	15	0	153	57	1221	3	4	1427	24
Reduct Vol:	0	0	0	0	0	0	0	0	0	0	0	0
Reduced Vol:	2	3	0	15	0	153	57	1221	3	4	1427	24
PCE Adj:	1.00	1.00	1.00	1.00	1.00	1.00	1.00	1.00	1.00	1.00	1.00	1.00
MLF Adj:	1.00	1.00	1.00	1.00	1.00	1.00	1.00	1.00	1.00	1.00	1.00	1.00
FinalVolume:	2	3	0	15	0	153	57	1221	3	4	1427	24

Saturation Flow Module:

Sat/Lane:	1700	1700	1700	1700	1700	1700	1700	1700	1700	1700	1700	1700
Adjustment:	1.00	1.00	1.00	1.00	1.00	1.00	1.00	1.00	1.00	1.00	1.00	1.00
Lanes:	1.00	1.00	0.00	1.00	0.00	1.00	1.00	2.00	1.00	1.00	2.00	1.00
Final Sat.:	1700	1700	0	1700	0	1700	1700	3400	1700	1700	3400	1700

Capacity Analysis Module:

Vol/Sat:	0.00	0.00	0.00	0.01	0.00	0.09	0.03	0.36	0.00	0.00	0.42	0.01
Crit Moves:	****				****	****				****		

Level Of Service Computation Report

ICU 1(Loss as Cycle Length %) Method (Base Volume Alternative)

Intersection #6 Av. La Pata/Ortega

Cycle (sec): 100 Critical Vol./Cap.(X): 0.654
Loss Time (sec): 5 Average Delay (sec/veh): xxxxxx
Optimal Cycle: 33 Level Of Service: B

Table with 4 columns: North Bound, South Bound, East Bound, West Bound. Rows include Movement, Control, Rights, Min. Green, Y+R, and Lanes.

Volume Module: Table with 12 columns representing different volume categories and their values.

Saturation Flow Module: Table with 12 columns representing saturation flow values for different lanes.

Capacity Analysis Module: Table with 12 columns representing capacity analysis metrics.

Level Of Service Computation Report

ICU 1(Loss as Cycle Length %) Method (Base Volume Alternative)

Intersection #7 Av. La Pata/Stallion

Cycle (sec): 100 Critical Vol./Cap.(X): 0.424
Loss Time (sec): 5 Average Delay (sec/veh): xxxxxx
Optimal Cycle: 21 Level Of Service: A

Table with 4 columns: North Bound, South Bound, East Bound, West Bound. Rows include Movement, Control, Rights, Min. Green, Y+R, and Lanes.

Volume Module: Table with 12 columns representing different traffic movements and 10 rows of volume-related metrics.

Saturation Flow Module: Table with 12 columns representing different traffic movements and 4 rows of saturation flow metrics.

Capacity Analysis Module: Table with 12 columns representing different traffic movements and 2 rows of capacity analysis metrics.

Impact Analysis Report
Level Of Service

Intersection	Base		Future		Change in
	LOS	Del/ Veh C	LOS	Del/ Veh C	
# 1 I-5 SB Ramps/Ortega	B	xxxxxx 0.680	B	xxxxxx 0.680	+ 0.000 V/C
# 2 I- NB Ramps/Ortega	B	xxxxxx 0.688	B	xxxxxx 0.688	+ 0.000 V/C
# 3 Rancho Viejo/Ortega	C	xxxxxx 0.789	C	xxxxxx 0.789	+ 0.000 V/C
# 4 La Novia/Ortega	B	xxxxxx 0.670	B	xxxxxx 0.670	+ 0.000 V/C
# 5 Reata/Ortega	A	xxxxxx 0.562	A	xxxxxx 0.562	+ 0.000 V/C
# 6 Av. La Pata/Ortega	B	xxxxxx 0.607	B	xxxxxx 0.607	+ 0.000 V/C
# 7 Av. La Pata/Stallion	A	xxxxxx 0.308	A	xxxxxx 0.308	+ 0.000 V/C

Level Of Service Computation Report

ICU 1(Loss as Cycle Length %) Method (Base Volume Alternative)

Intersection #1 I-5 SB Ramps/Ortega

Cycle (sec): 100 Critical Vol./Cap.(X): 0.680
Loss Time (sec): 5 Average Delay (sec/veh): xxxxxx
Optimal Cycle: 35 Level Of Service: B

Table with 4 columns: North Bound, South Bound, East Bound, West Bound. Rows include Movement, Control, Rights, Min. Green, Y+R, and Lanes.

Volume Module: Table with 12 columns representing different volume categories and 13 rows of data.

Saturation Flow Module: Table with 12 columns representing saturation flow values and 5 rows of data.

Capacity Analysis Module: Table with 12 columns representing capacity analysis values and 3 rows of data.

Level Of Service Computation Report

ICU 1(Loss as Cycle Length %) Method (Base Volume Alternative)

Intersection #2 I- NB Ramps/Ortega

Cycle (sec): 100 Critical Vol./Cap.(X): 0.688
Loss Time (sec): 5 Average Delay (sec/veh): xxxxxx
Optimal Cycle: 36 Level Of Service: B

Table with 4 columns: North Bound, South Bound, East Bound, West Bound. Rows include Approach, Movement, Control, Rights, Min. Green, Y+R, and Lanes.

Volume Module: Table with 12 columns representing different traffic movements and 10 rows of volume-related metrics like Base Vol, Growth Adj, etc.

Saturation Flow Module: Table with 12 columns and 4 rows showing Sat/Lane, Adjustment, Lanes, and Final Sat.

Capacity Analysis Module: Table with 12 columns and 2 rows showing Vol/Sat and Crit Moves.

Level Of Service Computation Report

ICU 1(Loss as Cycle Length %) Method (Base Volume Alternative)

Intersection #3 Rancho Viejo/Ortega

Cycle (sec): 100 Critical Vol./Cap.(X): 0.789
Loss Time (sec): 5 Average Delay (sec/veh): xxxxxx
Optimal Cycle: 50 Level Of Service: C

Table with 4 columns: North Bound, South Bound, East Bound, West Bound. Rows include Approach, Movement, Control, Rights, Min. Green, Y+R, and Lanes.

Volume Module: Table with 12 columns representing different traffic movements and 10 rows of volume-related metrics like Base Vol, Growth Adj, etc.

Saturation Flow Module: Table with 12 columns and 4 rows showing Sat/Lane, Adjustment, Lanes, and Final Sat.

Capacity Analysis Module: Table with 12 columns and 3 rows showing Vol/Sat, OvlAdjV/S, and Crit Moves.

Level Of Service Computation Report

ICU 1(Loss as Cycle Length %) Method (Base Volume Alternative)

Intersection #4 La Novia/Ortega

Cycle (sec): 100 Critical Vol./Cap.(X): 0.670
Loss Time (sec): 5 Average Delay (sec/veh): xxxxxx
Optimal Cycle: 34 Level Of Service: B

Table with 4 columns: North Bound, South Bound, East Bound, West Bound. Rows include Movement, Control, Rights, Min. Green, Y+R, and Lanes.

Volume Module: Table with 12 columns representing different volume categories and 12 rows for various adjustment factors like Base Vol, Growth Adj, etc.

Saturation Flow Module: Table with 12 columns for saturation flow and 4 rows for Sat/Lane, Adjustment, Lanes, and Final Sat.

Capacity Analysis Module: Table with 12 columns for capacity analysis and 3 rows for Vol/Sat, Crit Moves, and a summary row.

 Level Of Service Computation Report
 ICU 1(Loss as Cycle Length %) Method (Base Volume Alternative)

 Intersection #5 Reata/Ortega

Cycle (sec): 100 Critical Vol./Cap.(X): 0.562
 Loss Time (sec): 5 Average Delay (sec/veh): xxxxxx
 Optimal Cycle: 27 Level Of Service: A

Approach:	North Bound				South Bound				East Bound				West Bound												
Movement:	L	-	T	-	R	L	-	T	-	R	L	-	T	-	R	L	-	T	-	R					
Control:	Permitted				Permitted				Protected				Protected												
Rights:	Include				Include				Include				Include												
Min. Green:	0	0	0	0	0	0	0	0	0	0	0	0	0	0	0	0	0	0	0	0	0	0	0		
Y+R:	4.0	4.0	4.0	4.0	4.0	4.0	4.0	4.0	4.0	4.0	4.0	4.0	4.0	4.0	4.0	4.0	4.0	4.0	4.0	4.0	4.0	4.0	4.0		
Lanes:	1	0	0	1	0	1	0	0	1	0	1	0	2	0	1	1	0	2	0	1	1	0	2	0	1

Volume Module:

Base Vol:	2	0	4	29	0	96	81	1525	3	10	1026	14
Growth Adj:	1.00	1.00	1.00	1.00	1.00	1.00	1.00	1.00	1.00	1.00	1.00	1.00
Initial Bse:	2	0	4	29	0	96	81	1525	3	10	1026	14
User Adj:	1.00	1.00	1.00	1.00	1.00	1.00	1.00	1.00	1.00	1.00	1.00	1.00
PHF Adj:	1.00	1.00	1.00	1.00	1.00	1.00	1.00	1.00	1.00	1.00	1.00	1.00
PHF Volume:	2	0	4	29	0	96	81	1525	3	10	1026	14
Reduct Vol:	0	0	0	0	0	0	0	0	0	0	0	0
Reduced Vol:	2	0	4	29	0	96	81	1525	3	10	1026	14
PCE Adj:	1.00	1.00	1.00	1.00	1.00	1.00	1.00	1.00	1.00	1.00	1.00	1.00
MLF Adj:	1.00	1.00	1.00	1.00	1.00	1.00	1.00	1.00	1.00	1.00	1.00	1.00
FinalVolume:	2	0	4	29	0	96	81	1525	3	10	1026	14

Saturation Flow Module:

Sat/Lane:	1700	1700	1700	1700	1700	1700	1700	1700	1700	1700	1700	1700
Adjustment:	1.00	1.00	1.00	1.00	1.00	1.00	1.00	1.00	1.00	1.00	1.00	1.00
Lanes:	1.00	0.00	1.00	1.00	0.00	1.00	1.00	2.00	1.00	1.00	2.00	1.00
Final Sat.:	1700	0	1700	1700	0	1700	1700	3400	1700	1700	3400	1700

Capacity Analysis Module:

Vol/Sat:	0.00	0.00	0.00	0.02	0.00	0.06	0.05	0.45	0.00	0.01	0.30	0.01
Crit Moves:	****					****		****		****		

Level Of Service Computation Report

ICU 1(Loss as Cycle Length %) Method (Base Volume Alternative)

Intersection #6 Av. La Pata/Ortega

Cycle (sec): 100 Critical Vol./Cap.(X): 0.607
Loss Time (sec): 5 Average Delay (sec/veh): xxxxxx
Optimal Cycle: 29 Level Of Service: B

Table with 4 columns: North Bound, South Bound, East Bound, West Bound. Rows include Approach, Movement, Control, Rights, Min. Green, Y+R, and Lanes.

Volume Module: Table with 12 columns representing different volume and adjustment factors like Base Vol, Growth Adj, Initial Bse, etc.

Saturation Flow Module: Table with 12 columns representing saturation flow factors like Sat/Lane, Adjustment, Lanes, Final Sat.

Capacity Analysis Module: Table with 12 columns representing capacity analysis factors like Vol/Sat, OvlAdjV/S, Crit Moves.

Level Of Service Computation Report

ICU 1(Loss as Cycle Length %) Method (Base Volume Alternative)

Intersection #7 Av. La Pata/Stallion

Cycle (sec): 100 Critical Vol./Cap.(X): 0.308
Loss Time (sec): 5 Average Delay (sec/veh): xxxxxx
Optimal Cycle: 18 Level Of Service: A

Table with 4 columns: North Bound, South Bound, East Bound, West Bound. Rows include Movement, Control, Rights, Min. Green, Y+R, and Lanes.

Volume Module: Table with 12 columns representing different traffic movements and 10 rows of volume-related metrics.

Saturation Flow Module: Table with 12 columns and 4 rows showing saturation flow and adjustment factors.

Capacity Analysis Module: Table with 12 columns and 3 rows showing capacity analysis metrics.

 Impact Analysis Report
 Level Of Service

Intersection	Base		Future		Change in
	LOS	Veh C	LOS	Veh C	
# 1 I-5 SB Ramps/Ortega	B	xxxxxx 0.644	B	xxxxxx 0.644	+ 0.000 V/C
# 2 I- NB Ramps/Ortega	C	xxxxxx 0.719	C	xxxxxx 0.719	+ 0.000 V/C
# 3 Rancho Viejo/Ortega	B	xxxxxx 0.651	B	xxxxxx 0.651	+ 0.000 V/C
# 4 La Novia/Ortega	B	xxxxxx 0.641	B	xxxxxx 0.641	+ 0.000 V/C
# 5 Reata/Ortega	A	xxxxxx 0.595	A	xxxxxx 0.595	+ 0.000 V/C
# 6 Av. La Pata/Ortega	B	xxxxxx 0.655	B	xxxxxx 0.655	+ 0.000 V/C
# 7 Av. La Pata/Stallion	A	xxxxxx 0.425	A	xxxxxx 0.425	+ 0.000 V/C

Level Of Service Computation Report
ICU 1(Loss as Cycle Length %) Method (Base Volume Alternative)

Intersection #1 I-5 SB Ramps/Ortega

Cycle (sec): 100 Critical Vol./Cap.(X): 0.644
Loss Time (sec): 5 Average Delay (sec/veh): xxxxxx
Optimal Cycle: 32 Level Of Service: B

Approach: North Bound South Bound East Bound West Bound
Movement: L - T - R L - T - R L - T - R L - T - R

Control: Split Phase Split Phase Protected Protected
Rights: Include Include Ignore Include
Min. Green: 0 0 0 0 0 0 0 0 0 0 0 0 0
Y+R: 4.0 4.0 4.0 4.0 4.0 4.0 4.0 4.0 4.0 4.0 4.0 4.0
Lanes: 0 0 0 0 0 2 0 0 0 2 0 0 3 0 1 2 0 2 0 0

Volume Module:
Base Vol: 0 0 0 870 0 936 0 1162 194 309 652 0
Growth Adj: 1.00 1.00 1.00 1.00 1.00 1.00 1.00 1.00 1.00 1.00 1.00 1.00
Initial Bse: 0 0 0 870 0 936 0 1162 194 309 652 0
User Adj: 1.00 1.00 1.00 1.00 1.00 1.00 1.00 1.00 0.00 1.00 1.00 1.00
PHF Adj: 1.00 1.00 1.00 1.00 1.00 1.00 1.00 1.00 0.00 1.00 1.00 1.00
PHF Volume: 0 0 0 870 0 936 0 1162 0 309 652 0
Reduct Vol: 0 0 0 0 0 0 0 0 0 0 0 0
Reduced Vol: 0 0 0 870 0 936 0 1162 0 309 652 0
PCE Adj: 1.00 1.00 1.00 1.00 1.00 1.00 1.00 1.00 0.00 1.00 1.00 1.00
MLF Adj: 1.00 1.00 1.00 1.00 1.00 1.00 1.00 1.00 0.00 1.00 1.00 1.00
FinalVolume: 0 0 0 870 0 936 0 1162 0 309 652 0

Saturation Flow Module:
Sat/Lane: 1700 1700 1700 1700 1700 1700 1700 1700 1700 1700 1700 1700
Adjustment: 1.00 1.00 1.00 1.00 1.00 1.00 1.00 1.00 1.00 1.00 1.00 1.00
Lanes: 0.00 0.00 0.00 2.00 0.00 2.00 0.00 3.00 1.00 2.00 2.00 0.00
Final Sat.: 0 0 0 3400 0 3400 0 5100 1700 3400 3400 0

Capacity Analysis Module:
Vol/Sat: 0.00 0.00 0.00 0.26 0.00 0.28 0.00 0.23 0.00 0.09 0.19 0.00
Crit Moves: **** **** ****

Level Of Service Computation Report
ICU 1(Loss as Cycle Length %) Method (Base Volume Alternative)

Intersection #2 I- NB Ramps/Ortega

Cycle (sec): 100 Critical Vol./Cap.(X): 0.719
Loss Time (sec): 5 Average Delay (sec/veh): xxxxxx
Optimal Cycle: 39 Level Of Service: C

Table with 4 columns: North Bound, South Bound, East Bound, West Bound. Rows include Movement, Control, Rights, Min. Green, Y+R, and Lanes.

Volume Module: Table with 12 columns representing different traffic movements and 10 rows of volume-related metrics like Base Vol, Growth Adj, etc.

Saturation Flow Module: Table with 12 columns and 4 rows showing Sat/Lane, Adjustment, Lanes, and Final Sat.

Capacity Analysis Module: Table with 12 columns and 3 rows showing Vol/Sat, Crit Moves, and other capacity metrics.

```

-----
Level Of Service Computation Report
ICU 1(Loss as Cycle Length %) Method (Base Volume Alternative)
*****
Intersection #3 Rancho Viejo/Ortega
*****
Cycle (sec):          100          Critical Vol./Cap.(X):          0.651
Loss Time (sec):      5            Average Delay (sec/veh):        xxxxxx
Optimal Cycle:        33           Level Of Service:                B
*****
Approach:      North Bound      South Bound      East Bound      West Bound
Movement:      L - T - R      L - T - R      L - T - R      L - T - R
-----|-----|-----|-----|
Control:        Split Phase      Split Phase      Protected      Protected
Rights:         Include          Include          Ovl           Include
Min. Green:     0 0 0      0 0 0      0 0 0      0 0 0
Y+R:            4.0 4.0 4.0  4.0 4.0 4.0  4.0 4.0 4.0  4.0 4.0 4.0
Lanes:          1 1 0 1 0    1 1 0 1 0    1 0 2 0 1    1 0 3 0 1
-----|-----|-----|-----|
Volume Module:
Base Vol:       269 134 58 166 124 109 236 1064 567 71 1492 419
Growth Adj:    1.00 1.00 1.00 1.00 1.00 1.00 1.00 1.00 1.00 1.00 1.00 1.00
Initial Bse:    269 134 58 166 124 109 236 1064 567 71 1492 419
User Adj:       1.00 1.00 1.00 1.00 1.00 1.00 1.00 1.00 1.00 1.00 1.00 1.00
PHF Adj:        1.00 1.00 1.00 1.00 1.00 1.00 1.00 1.00 1.00 1.00 1.00 1.00
PHF Volume:     269 134 58 166 124 109 236 1064 567 71 1492 419
Reduct Vol:     0 0 0 0 0 0 0 0 0 0 0 0
Reduced Vol:    269 134 58 166 124 109 236 1064 567 71 1492 419
PCE Adj:        1.00 1.00 1.00 1.00 1.00 1.00 1.00 1.00 1.00 1.00 1.00 1.00
MLF Adj:        1.00 1.00 1.00 1.00 1.00 1.00 1.00 1.00 1.00 1.00 1.00 1.00
FinalVolume:    269 134 58 166 124 109 236 1064 567 71 1492 419
OvlAdjVol:                                     413
-----|-----|-----|-----|
Saturation Flow Module:
Sat/Lane:       1700 1700 1700 1700 1700 1700 1700 1700 1700 1700 1700 1700
Adjustment:     1.00 1.00 1.00 1.00 1.00 1.00 1.00 1.00 1.00 1.00 1.00 1.00
Lanes:          1.75 0.87 0.38 1.26 0.93 0.81 1.00 2.00 1.00 1.00 3.00 1.00
Final Sat.:     2984 1478 638 2128 1587 1385 1700 3400 1700 1700 5100 1700
-----|-----|-----|-----|
Capacity Analysis Module:
Vol/Sat:        0.09 0.09 0.09 0.08 0.08 0.08 0.14 0.31 0.33 0.04 0.29 0.25
OvlAdjV/S:                                     0.24
Crit Moves:          ****          ****  ****          ****
*****

```

Level Of Service Computation Report
ICU 1(Loss as Cycle Length %) Method (Base Volume Alternative)

Intersection #4 La Novia/Ortega

Cycle (sec): 100 Critical Vol./Cap.(X): 0.641
Loss Time (sec): 5 Average Delay (sec/veh): xxxxxx
Optimal Cycle: 32 Level Of Service: B

Table with 4 columns: North Bound, South Bound, East Bound, West Bound. Rows include Movement, Control, Rights, Min. Green, Y+R, and Lanes.

Volume Module: Table with 12 columns representing different traffic movements and 10 rows of volume-related metrics.

Saturation Flow Module: Table with 12 columns representing different traffic movements and 4 rows of saturation flow metrics.

Capacity Analysis Module: Table with 12 columns representing different traffic movements and 2 rows of capacity analysis metrics.

Level Of Service Computation Report
ICU 1(Loss as Cycle Length %) Method (Base Volume Alternative)

Intersection #5 Reata/Ortega

Cycle (sec): 100 Critical Vol./Cap.(X): 0.595
Loss Time (sec): 5 Average Delay (sec/veh): xxxxxx
Optimal Cycle: 29 Level Of Service: A

Approach:	North Bound			South Bound			East Bound			West Bound		
Movement:	L	T	R	L	T	R	L	T	R	L	T	R
Control:	Permitted			Permitted			Protected			Protected		
Rights:	Include			Include			Include			Include		
Min. Green:	0	0	0	0	0	0	0	0	0	0	0	0
Y+R:	4.0	4.0	4.0	4.0	4.0	4.0	4.0	4.0	4.0	4.0	4.0	4.0
Lanes:	1	0	0	1	0	0	1	0	2	0	1	1

Volume Module:

Base Vol:	2	3	0	15	0	153	57	1224	3	4	1430	24
Growth Adj:	1.00	1.00	1.00	1.00	1.00	1.00	1.00	1.00	1.00	1.00	1.00	1.00
Initial Bse:	2	3	0	15	0	153	57	1224	3	4	1430	24
User Adj:	1.00	1.00	1.00	1.00	1.00	1.00	1.00	1.00	1.00	1.00	1.00	1.00
PHF Adj:	1.00	1.00	1.00	1.00	1.00	1.00	1.00	1.00	1.00	1.00	1.00	1.00
PHF Volume:	2	3	0	15	0	153	57	1224	3	4	1430	24
Reduct Vol:	0	0	0	0	0	0	0	0	0	0	0	0
Reduced Vol:	2	3	0	15	0	153	57	1224	3	4	1430	24
PCE Adj:	1.00	1.00	1.00	1.00	1.00	1.00	1.00	1.00	1.00	1.00	1.00	1.00
MLF Adj:	1.00	1.00	1.00	1.00	1.00	1.00	1.00	1.00	1.00	1.00	1.00	1.00
FinalVolume:	2	3	0	15	0	153	57	1224	3	4	1430	24

Saturation Flow Module:

Sat/Lane:	1700	1700	1700	1700	1700	1700	1700	1700	1700	1700	1700	1700
Adjustment:	1.00	1.00	1.00	1.00	1.00	1.00	1.00	1.00	1.00	1.00	1.00	1.00
Lanes:	1.00	1.00	0.00	1.00	0.00	1.00	1.00	2.00	1.00	1.00	2.00	1.00
Final Sat.:	1700	1700	0	1700	0	1700	1700	3400	1700	1700	3400	1700

Capacity Analysis Module:

Vol/Sat:	0.00	0.00	0.00	0.01	0.00	0.09	0.03	0.36	0.00	0.00	0.42	0.01
Crit Moves:	****					****	****				****	

Level Of Service Computation Report
 ICU 1(Loss as Cycle Length %) Method (Base Volume Alternative)

 Intersection #6 Av. La Pata/Ortega

Cycle (sec): 100 Critical Vol./Cap.(X): 0.655
 Loss Time (sec): 5 Average Delay (sec/veh): xxxxxx
 Optimal Cycle: 33 Level Of Service: B

Approach:	North Bound			South Bound			East Bound			West Bound														
Movement:	L	T	R	L	T	R	L	T	R	L	T	R												
Control:	Protected			Protected			Protected			Protected														
Rights:	Include			Ovl			Include			Include														
Min. Green:	0	0	0	0	0	0	0	0	0	0	0	0												
Y+R:	4.0	4.0	4.0	4.0	4.0	4.0	4.0	4.0	4.0	4.0	4.0	4.0												
Lanes:	2	0	3	0	1		1	0	3	0	2		2	0	2	0	1		1	0	2	0	1	

Volume Module:

Base Vol:	431	494	40	117	726	568	487	199	388	161	654	291
Growth Adj:	1.00	1.00	1.00	1.00	1.00	1.00	1.00	1.00	1.00	1.00	1.00	1.00
Initial Bse:	431	494	40	117	726	568	487	199	388	161	654	291
User Adj:	1.00	1.00	1.00	1.00	1.00	1.00	1.00	1.00	1.00	1.00	1.00	1.00
PHF Adj:	1.00	1.00	1.00	1.00	1.00	1.00	1.00	1.00	1.00	1.00	1.00	1.00
PHF Volume:	431	494	40	117	726	568	487	199	388	161	654	291
Reduct Vol:	0	0	0	0	0	0	0	0	0	0	0	0
Reduced Vol:	431	494	40	117	726	568	487	199	388	161	654	291
PCE Adj:	1.00	1.00	1.00	1.00	1.00	1.00	1.00	1.00	1.00	1.00	1.00	1.00
MLF Adj:	1.00	1.00	1.00	1.00	1.00	1.00	1.00	1.00	1.00	1.00	1.00	1.00
FinalVolume:	431	494	40	117	726	568	487	199	388	161	654	291
OvlAdjVol:	81											

Saturation Flow Module:

Sat/Lane:	1700	1700	1700	1700	1700	1700	1700	1700	1700	1700	1700	1700
Adjustment:	1.00	1.00	1.00	1.00	1.00	1.00	1.00	1.00	1.00	1.00	1.00	1.00
Lanes:	2.00	3.00	1.00	1.00	3.00	2.00	2.00	2.00	1.00	1.00	2.00	1.00
Final Sat.:	3400	5100	1700	1700	5100	3400	3400	3400	1700	1700	3400	1700

Capacity Analysis Module:

Vol/Sat:	0.13	0.10	0.02	0.07	0.14	0.17	0.14	0.06	0.23	0.09	0.19	0.17
OvlAdjV/S:	0.02											
Crit Moves:	****	****					****	****				

Level Of Service Computation Report
 ICU 1(Loss as Cycle Length %) Method (Base Volume Alternative)

 Intersection #7 Av. La Pata/Stallion

Cycle (sec): 100 Critical Vol./Cap.(X): 0.425
 Loss Time (sec): 5 Average Delay (sec/veh): xxxxxx
 Optimal Cycle: 21 Level Of Service: A

Approach:	North Bound				South Bound				East Bound				West Bound							
Movement:	L	-	T	-	R	L	-	T	-	R	L	-	T	-	R	L	-	T	-	R
Control:	Protected				Protected				Protected				Protected							
Rights:	Include				Ignore				Include				Include							
Min. Green:	0	0	0	0	0	0	0	0	0	0	0	0	0	0	0	0	0	0	0	0
Y+R:	4.0	4.0	4.0	4.0	4.0	4.0	4.0	4.0	4.0	4.0	4.0	4.0	4.0	4.0	4.0	4.0	4.0	4.0	4.0	4.0
Lanes:	1	0	1	1	0	1	0	3	0	1	2	0	0	1	0	1	0	0	1	0

Volume Module:

Base Vol:	178	466	4	20	495	819	551	0	109	7	0	19
Growth Adj:	1.00	1.00	1.00	1.00	1.00	1.00	1.00	1.00	1.00	1.00	1.00	1.00
Initial Bse:	178	466	4	20	495	819	551	0	109	7	0	19
User Adj:	1.00	1.00	1.00	1.00	1.00	0.00	1.00	1.00	1.00	1.00	1.00	1.00
PHF Adj:	1.00	1.00	1.00	1.00	1.00	0.00	1.00	1.00	1.00	1.00	1.00	1.00
PHF Volume:	178	466	4	20	495	0	551	0	109	7	0	19
Reduct Vol:	0	0	0	0	0	0	0	0	0	0	0	0
Reduced Vol:	178	466	4	20	495	0	551	0	109	7	0	19
PCE Adj:	1.00	1.00	1.00	1.00	1.00	0.00	1.00	1.00	1.00	1.00	1.00	1.00
MLF Adj:	1.00	1.00	1.00	1.00	1.00	0.00	1.00	1.00	1.00	1.00	1.00	1.00
FinalVolume:	178	466	4	20	495	0	551	0	109	7	0	19

Saturation Flow Module:

Sat/Lane:	1700	1700	1700	1700	1700	1700	1700	1700	1700	1700	1700	1700
Adjustment:	1.00	1.00	1.00	1.00	1.00	1.00	1.00	1.00	1.00	1.00	1.00	1.00
Lanes:	1.00	1.98	0.02	1.00	3.00	1.00	2.00	0.00	1.00	1.00	0.00	1.00
Final Sat.:	1700	3371	29	1700	5100	1700	3400	0	1700	1700	0	1700

Capacity Analysis Module:

Vol/Sat:	0.10	0.14	0.14	0.01	0.10	0.00	0.16	0.00	0.06	0.00	0.00	0.01
Crit Moves:	****			****			****			****	****	

Impact Analysis Report
Level Of Service

Intersection	Base		Future		Change in
	Del/ LOS	V/ Veh C	Del/ LOS	V/ Veh C	
# 1 I-5 SB Ramps/Ortega	B	xxxxxx 0.681	B	xxxxxx 0.681	+ 0.000 V/C
# 2 I- NB Ramps/Ortega	B	xxxxxx 0.689	B	xxxxxx 0.689	+ 0.000 V/C
# 3 Rancho Viejo/Ortega	C	xxxxxx 0.790	C	xxxxxx 0.790	+ 0.000 V/C
# 4 La Novia/Ortega	B	xxxxxx 0.671	B	xxxxxx 0.671	+ 0.000 V/C
# 5 Reata/Ortega	A	xxxxxx 0.563	A	xxxxxx 0.563	+ 0.000 V/C
# 6 Av. La Pata/Ortega	B	xxxxxx 0.607	B	xxxxxx 0.607	+ 0.000 V/C
# 7 Av. La Pata/Stallion	A	xxxxxx 0.309	A	xxxxxx 0.309	+ 0.000 V/C

Level Of Service Computation Report
ICU 1(Loss as Cycle Length %) Method (Base Volume Alternative)

Intersection #1 I-5 SB Ramps/Ortega

Cycle (sec): 100 Critical Vol./Cap.(X): 0.681
Loss Time (sec): 5 Average Delay (sec/veh): xxxxxx
Optimal Cycle: 35 Level Of Service: B

Table with 4 columns: North Bound, South Bound, East Bound, West Bound. Rows include Movement, Control, Rights, Min. Green, Y+R, and Lanes.

Volume Module table with 12 columns representing different volume categories and 12 rows of adjustment factors.

Saturation Flow Module table with 12 columns and 4 rows showing saturation flow rates and adjustments.

Capacity Analysis Module table with 12 columns and 2 rows showing Vol/Sat and Crit Moves.

```

-----
Level Of Service Computation Report
ICU 1(Loss as Cycle Length %) Method (Base Volume Alternative)
*****
Intersection #2 I- NB Ramps/Ortega
*****
Cycle (sec):          100          Critical Vol./Cap.(X):          0.689
Loss Time (sec):      5            Average Delay (sec/veh):        xxxxxx
Optimal Cycle:        36           Level Of Service:                B
*****
Approach:             North Bound      South Bound      East Bound      West Bound
Movement:             L - T - R      L - T - R      L - T - R      L - T - R
-----|-----|-----|-----|
Control:               Split Phase      Split Phase      Protected      Protected
Rights:                Include          Include          Include          Include
Min. Green:            0 0 0           0 0 0           0 0 0           0 0 0 0
Y+R:                   4.0 4.0 4.0     4.0 4.0 4.0     4.0 4.0 4.0     4.0 4.0 4.0
Lanes:                 0 0 1! 0 1      1 0 0 0 1      1 0 2 1 1      0 0 2 1 0
-----|-----|-----|-----|
Volume Module:
Base Vol:              164 18 391      40 0 116        48 1522 536      0 1823 82
Growth Adj:            1.00 1.00 1.00  1.00 1.00 1.00  1.00 1.00 1.00  1.00 1.00 1.00
Initial Bse:           164 18 391      40 0 116        48 1522 536      0 1823 82
User Adj:              1.00 1.00 1.00  1.00 1.00 1.00  1.00 1.00 1.00  1.00 1.00 1.00
PHF Adj:              1.00 1.00 1.00  1.00 1.00 1.00  1.00 1.00 1.00  1.00 1.00 1.00
PHF Volume:           164 18 391      40 0 116        48 1522 536      0 1823 82
Reduct Vol:            0 0 0           0 0 0           0 0 0           0 0 0 0
Reduced Vol:          164 18 391      40 0 116        48 1522 536      0 1823 82
PCE Adj:              1.00 1.00 1.00  1.00 1.00 1.00  1.00 1.00 1.00  1.00 1.00 1.00
MLF Adj:              1.00 1.00 1.00  1.00 1.00 1.00  1.00 1.00 1.00  1.00 1.00 1.00
FinalVolume:          164 18 391      40 0 116        48 1522 536      0 1823 82
-----|-----|-----|-----|
Saturation Flow Module:
Sat/Lane:              1700 1700 1700  1700 1700 1700  1700 1700 1700  1700 1700 1700
Adjustment:            1.00 1.00 1.00  1.00 1.00 1.00  1.00 1.00 1.00  1.00 1.00 1.00
Lanes:                 0.57 0.06 1.37  1.00 0.00 1.00  1.00 2.96 1.04  0.00 2.87 0.13
Final Sat.:           973 107 2320  1700 0 1700  1700 5029 1771  0 4880 220
-----|-----|-----|-----|
Capacity Analysis Module:
Vol/Sat:               0.17 0.17 0.17  0.02 0.00 0.07  0.03 0.30 0.30  0.00 0.37 0.37
Crit Moves:            ****          ****  ****          ****
*****

```

Level Of Service Computation Report
 ICU 1(Loss as Cycle Length %) Method (Base Volume Alternative)

 Intersection #3 Rancho Viejo/Ortega

Cycle (sec): 100 Critical Vol./Cap.(X): 0.790
 Loss Time (sec): 5 Average Delay (sec/veh): xxxxxx
 Optimal Cycle: 50 Level Of Service: C

Approach:	North Bound			South Bound			East Bound			West Bound		
Movement:	L	T	R	L	T	R	L	T	R	L	T	R
Control:	Split Phase			Split Phase			Protected			Protected		
Rights:	Include			Include			Ovl			Include		
Min. Green:	0	0	0	0	0	0	0	0	0	0	0	0
Y+R:	4.0	4.0	4.0	4.0	4.0	4.0	4.0	4.0	4.0	4.0	4.0	4.0
Lanes:	1	1	0	1	1	0	1	0	2	1	0	3

Volume Module:

Base Vol:	420	106	97	275	125	277	161	1443	358	49	1128	214
Growth Adj:	1.00	1.00	1.00	1.00	1.00	1.00	1.00	1.00	1.00	1.00	1.00	1.00
Initial Bse:	420	106	97	275	125	277	161	1443	358	49	1128	214
User Adj:	1.00	1.00	1.00	1.00	1.00	1.00	1.00	1.00	1.00	1.00	1.00	1.00
PHF Adj:	1.00	1.00	1.00	1.00	1.00	1.00	1.00	1.00	1.00	1.00	1.00	1.00
PHF Volume:	420	106	97	275	125	277	161	1443	358	49	1128	214
Reduct Vol:	0	0	0	0	0	0	0	0	0	0	0	0
Reduced Vol:	420	106	97	275	125	277	161	1443	358	49	1128	214
PCE Adj:	1.00	1.00	1.00	1.00	1.00	1.00	1.00	1.00	1.00	1.00	1.00	1.00
MLF Adj:	1.00	1.00	1.00	1.00	1.00	1.00	1.00	1.00	1.00	1.00	1.00	1.00
FinalVolume:	420	106	97	275	125	277	161	1443	358	49	1128	214
OvlAdjVol:											148	

Saturation Flow Module:

Sat/Lane:	1700	1700	1700	1700	1700	1700	1700	1700	1700	1700	1700	1700
Adjustment:	1.00	1.00	1.00	1.00	1.00	1.00	1.00	1.00	1.00	1.00	1.00	1.00
Lanes:	2.00	0.52	0.48	1.38	0.62	1.00	1.00	2.00	1.00	1.00	3.00	1.00
Final Sat.:	3400	888	812	2338	1063	1700	1700	3400	1700	1700	5100	1700

Capacity Analysis Module:

Vol/Sat:	0.12	0.12	0.12	0.12	0.12	0.16	0.09	0.42	0.21	0.03	0.22	0.13
OvlAdjV/S:									0.09			
Crit Moves:	****					****		****		****		

Level Of Service Computation Report

ICU 1(Loss as Cycle Length %) Method (Base Volume Alternative)

Intersection #4 La Novia/Ortega

Cycle (sec): 100 Critical Vol./Cap.(X): 0.671
Loss Time (sec): 5 Average Delay (sec/veh): xxxxxx
Optimal Cycle: 34 Level Of Service: B

Table with 4 columns: North Bound, South Bound, East Bound, West Bound. Rows include Movement, Control, Rights, Min. Green, Y+R, and Lanes.

Volume Module: Table with 12 columns representing different traffic movements and 10 rows of volume-related metrics.

Saturation Flow Module: Table with 12 columns and 4 rows showing saturation flow and adjustment factors.

Capacity Analysis Module: Table with 12 columns and 3 rows showing capacity analysis metrics.

Level Of Service Computation Report
ICU 1(Loss as Cycle Length %) Method (Base Volume Alternative)

Intersection #5 Reata/Ortega

Cycle (sec): 100 Critical Vol./Cap.(X): 0.563
Loss Time (sec): 5 Average Delay (sec/veh): xxxxxx
Optimal Cycle: 27 Level Of Service: A

Approach: North Bound South Bound East Bound West Bound
Movement: L - T - R L - T - R L - T - R L - T - R
Control: Permitted Permitted Protected Protected
Rights: Include Include Include Include
Min. Green: 0 0 0 0 0 0 0 0 0 0 0 0
Y+R: 4.0 4.0 4.0 4.0 4.0 4.0 4.0 4.0 4.0 4.0 4.0 4.0
Lanes: 1 0 0 1 0 1 0 0 1 0 1 0 2 0 1 1 0 2 0 1

Volume Module:
Base Vol: 2 0 4 29 0 96 81 1528 3 10 1029 14
Growth Adj: 1.00 1.00 1.00 1.00 1.00 1.00 1.00 1.00 1.00 1.00 1.00 1.00
Initial Bse: 2 0 4 29 0 96 81 1528 3 10 1029 14
User Adj: 1.00 1.00 1.00 1.00 1.00 1.00 1.00 1.00 1.00 1.00 1.00 1.00
PHF Adj: 1.00 1.00 1.00 1.00 1.00 1.00 1.00 1.00 1.00 1.00 1.00 1.00
PHF Volume: 2 0 4 29 0 96 81 1528 3 10 1029 14
Reduct Vol: 0 0 0 0 0 0 0 0 0 0 0 0
Reduced Vol: 2 0 4 29 0 96 81 1528 3 10 1029 14
PCE Adj: 1.00 1.00 1.00 1.00 1.00 1.00 1.00 1.00 1.00 1.00 1.00 1.00
MLF Adj: 1.00 1.00 1.00 1.00 1.00 1.00 1.00 1.00 1.00 1.00 1.00 1.00
FinalVolume: 2 0 4 29 0 96 81 1528 3 10 1029 14

Saturation Flow Module:
Sat/Lane: 1700 1700 1700 1700 1700 1700 1700 1700 1700 1700 1700 1700
Adjustment: 1.00 1.00 1.00 1.00 1.00 1.00 1.00 1.00 1.00 1.00 1.00 1.00
Lanes: 1.00 0.00 1.00 1.00 0.00 1.00 1.00 2.00 1.00 1.00 2.00 1.00
Final Sat.: 1700 0 1700 1700 0 1700 1700 3400 1700 1700 3400 1700

Capacity Analysis Module:
Vol/Sat: 0.00 0.00 0.00 0.02 0.00 0.06 0.05 0.45 0.00 0.01 0.30 0.01
Crit Moves: **** **** **** ****

```

-----
Level Of Service Computation Report
ICU 1(Loss as Cycle Length %) Method (Base Volume Alternative)
*****
Intersection #6 Av. La Pata/Ortega
*****
Cycle (sec):          100          Critical Vol./Cap.(X):          0.607
Loss Time (sec):      5            Average Delay (sec/veh):        xxxxxx
Optimal Cycle:        29            Level Of Service:                B
*****
Approach:             North Bound      South Bound      East Bound      West Bound
Movement:             L - T - R      L - T - R      L - T - R      L - T - R
-----|-----|-----|-----|
Control:              Protected      Protected      Protected      Protected
Rights:               Include       Ovl           Include       Include
Min. Green:           0  0  0        0  0  0        0  0  0        0  0  0
Y+R:                  4.0 4.0 4.0    4.0 4.0 4.0    4.0 4.0 4.0    4.0 4.0 4.0
Lanes:                2  0  3  0  1    1  0  3  0  2    2  0  2  0  1    1  0  2  0  1
-----|-----|-----|-----|
Volume Module:
Base Vol:             306  528  127    282  442  529    514  832  226    73  293  109
Growth Adj:           1.00 1.00  1.00    1.00 1.00  1.00    1.00 1.00  1.00    1.00 1.00  1.00
Initial Bse:          306  528  127    282  442  529    514  832  226    73  293  109
User Adj:             1.00 1.00  1.00    1.00 1.00  1.00    1.00 1.00  1.00    1.00 1.00  1.00
PHF Adj:              1.00 1.00  1.00    1.00 1.00  1.00    1.00 1.00  1.00    1.00 1.00  1.00
PHF Volume:           306  528  127    282  442  529    514  832  226    73  293  109
Reduct Vol:           0  0  0        0  0  0        0  0  0        0  0  0
Reduced Vol:          306  528  127    282  442  529    514  832  226    73  293  109
PCE Adj:              1.00 1.00  1.00    1.00 1.00  1.00    1.00 1.00  1.00    1.00 1.00  1.00
MLF Adj:              1.00 1.00  1.00    1.00 1.00  1.00    1.00 1.00  1.00    1.00 1.00  1.00
FinalVolume:          306  528  127    282  442  529    514  832  226    73  293  109
OvlAdjVol:                                15
-----|-----|-----|-----|
Saturation Flow Module:
Sat/Lane:             1700 1700  1700    1700 1700  1700    1700 1700  1700    1700 1700  1700
Adjustment:           1.00 1.00  1.00    1.00 1.00  1.00    1.00 1.00  1.00    1.00 1.00  1.00
Lanes:                2.00 3.00  1.00    1.00 3.00  2.00    2.00 2.00  1.00    1.00 2.00  1.00
Final Sat.:           3400 5100  1700    1700 5100  3400    3400 3400  1700    1700 3400  1700
-----|-----|-----|-----|
Capacity Analysis Module:
Vol/Sat:              0.09 0.10  0.07    0.17 0.09  0.16    0.15 0.24  0.13    0.04 0.09  0.06
OvlAdjV/S:                                0.00
Crit Moves:           ****          ****          ****          ****
*****

```

Level Of Service Computation Report
ICU 1(Loss as Cycle Length %) Method (Base Volume Alternative)

Intersection #7 Av. La Pata/Stallion

Cycle (sec): 100 Critical Vol./Cap.(X): 0.309
Loss Time (sec): 5 Average Delay (sec/veh): xxxxxx
Optimal Cycle: 18 Level Of Service: A

Table with 4 columns: North Bound, South Bound, East Bound, West Bound. Rows include Movement, Control, Rights, Min. Green, Y+R, and Lanes.

Volume Module: Table with 12 columns representing different traffic movements and 10 rows of adjustment factors like Base Vol, Growth Adj, etc.

Saturation Flow Module: Table with 12 columns and 4 rows showing Sat/Lane, Adjustment, Lanes, and Final Sat.

Capacity Analysis Module: Table with 12 columns and 3 rows showing Vol/Sat, Crit Moves, and asterisks for critical moves.













APPENDIX C

HCM WORKSHEETS

HCM 6th Signalized Intersection Summary

1: Ortega & I-5 SB Off-Ramp

08/02/2019

												
Movement	EBL	EBT	EBR	WBL	WBT	WBR	NBL	NBT	NBR	SBL	SBT	SBR
Lane Configurations		↑↑↑	↑	↑↑	↑↑					↑↑		↑↑
Traffic Volume (veh/h)	0	1162	194	308	652	0	0	0	0	868	0	936
Future Volume (veh/h)	0	1162	194	308	652	0	0	0	0	868	0	936
Initial Q (Qb), veh	0	0	0	0	0	0				0	0	0
Ped-Bike Adj(A_pbT)	1.00		1.00	1.00		1.00				1.00		1.00
Parking Bus, Adj	1.00	1.00	1.00	1.00	1.00	1.00				1.00	1.00	1.00
Work Zone On Approach		No			No						No	
Adj Sat Flow, veh/h/ln	0	1870	1870	1870	1870	0				1870	0	1870
Adj Flow Rate, veh/h	0	1223	0	324	686	0				914	0	985
Peak Hour Factor	0.95	0.95	0.95	0.95	0.95	0.95				0.95	0.95	0.95
Percent Heavy Veh, %	0	2	2	2	2	0				2	0	2
Cap, veh/h	0	1470		427	1729	0				1256	0	1014
Arrive On Green	0.00	0.29	0.00	0.12	0.49	0.00				0.36	0.00	0.36
Sat Flow, veh/h	0	5274	1585	3456	3647	0				3456	0	2790
Grp Volume(v), veh/h	0	1223	0	324	686	0				914	0	985
Grp Sat Flow(s),veh/h/ln	0	1702	1585	1728	1777	0				1728	0	1395
Q Serve(g_s), s	0.0	13.5	0.0	5.4	7.4	0.0				13.7	0.0	20.8
Cycle Q Clear(g_c), s	0.0	13.5	0.0	5.4	7.4	0.0				13.7	0.0	20.8
Prop In Lane	0.00		1.00	1.00		0.00				1.00		1.00
Lane Grp Cap(c), veh/h	0	1470		427	1729	0				1256	0	1014
V/C Ratio(X)	0.00	0.83		0.76	0.40	0.00				0.73	0.00	0.97
Avail Cap(c_a), veh/h	0	1532		432	1777	0				1256	0	1014
HCM Platoon Ratio	1.00	1.00	1.00	1.00	1.00	1.00				1.00	1.00	1.00
Upstream Filter(I)	0.00	1.00	0.00	1.00	1.00	0.00				1.00	0.00	1.00
Uniform Delay (d), s/veh	0.0	20.0	0.0	25.4	9.8	0.0				16.5	0.0	18.8
Incr Delay (d2), s/veh	0.0	3.9	0.0	7.5	0.1	0.0				2.2	0.0	21.5
Initial Q Delay(d3),s/veh	0.0	0.0	0.0	0.0	0.0	0.0				0.0	0.0	0.0
%ile BackOfQ(50%),veh/ln	0.0	5.4	0.0	2.5	2.5	0.0				5.2	0.0	8.9
Unsig. Movement Delay, s/veh												
LnGrp Delay(d),s/veh	0.0	24.0	0.0	33.0	10.0	0.0				18.7	0.0	40.3
LnGrp LOS	A	C		C	A	A				B	A	D
Approach Vol, veh/h		1223	A		1010						1899	
Approach Delay, s/veh		24.0			17.3						29.9	
Approach LOS		C			B						C	
Timer - Assigned Phs			3	4		6		8				
Phs Duration (G+Y+Rc), s			11.9	21.8		26.3		33.7				
Change Period (Y+Rc), s			4.5	4.5		4.5		4.5				
Max Green Setting (Gmax), s			7.5	18.0		21.0		30.0				
Max Q Clear Time (g_c+I1), s			7.4	15.5		22.8		9.4				
Green Ext Time (p_c), s			0.0	1.8		0.0		4.8				
Intersection Summary												
HCM 6th Ctrl Delay			25.1									
HCM 6th LOS			C									
Notes												
Unsignalized Delay for [EBR] is excluded from calculations of the approach delay and intersection delay.												

HCM 6th Signalized Intersection Summary
 2: I-5 NB Ramps & Ortega

08/02/2019



Movement	EBL	EBT	EBR	WBL	WBT	WBR	NBL	NBT	NBR	SBL	SBT	SBR
Lane Configurations												
Traffic Volume (veh/h)	34	1452	622	0	1680	58	144	26	678	28	0	98
Future Volume (veh/h)	34	1452	622	0	1680	58	144	26	678	28	0	98
Initial Q (Qb), veh	0	0	0	0	0	0	0	0	0	0	0	0
Ped-Bike Adj(A_pbT)	1.00		1.00	1.00		1.00	1.00		1.00	1.00		1.00
Parking Bus, Adj	1.00	1.00	1.00	1.00	1.00	1.00	1.00	1.00	1.00	1.00	1.00	1.00
Work Zone On Approach		No			No			No			No	
Adj Sat Flow, veh/h/ln	1870	1870	1870	0	1870	1870	1870	1870	1870	1870	1870	1870
Adj Flow Rate, veh/h	36	1692	546	0	1768	61	152	428	446	29	0	103
Peak Hour Factor	0.95	0.95	0.95	0.95	0.95	0.95	0.95	0.95	0.95	0.95	0.95	0.95
Percent Heavy Veh, %	2	2	2	0	2	2	2	2	2	2	2	2
Cap, veh/h	54	2369	669	0	1778	61	180	508	591	147	154	131
Arrive On Green	0.03	0.42	0.42	0.00	0.35	0.35	0.37	0.37	0.37	0.08	0.00	0.08
Sat Flow, veh/h	1781	5611	1585	0	5237	175	484	1362	1585	1781	1870	1585
Grp Volume(v), veh/h	36	1692	546	0	1187	642	580	0	446	29	0	103
Grp Sat Flow(s),veh/h/ln	1781	1870	1585	0	1702	1839	1846	0	1585	1781	1870	1585
Q Serve(g_s), s	2.2	27.4	33.4	0.0	38.2	38.3	31.6	0.0	27.0	1.7	0.0	7.0
Cycle Q Clear(g_c), s	2.2	27.4	33.4	0.0	38.2	38.3	31.6	0.0	27.0	1.7	0.0	7.0
Prop In Lane	1.00		1.00	0.00		0.10	0.26		1.00	1.00		1.00
Lane Grp Cap(c), veh/h	54	2369	669	0	1195	645	688	0	591	147	154	131
V/C Ratio(X)	0.67	0.71	0.82	0.00	0.99	0.99	0.84	0.00	0.76	0.20	0.00	0.79
Avail Cap(c_a), veh/h	83	2459	695	0	1195	645	688	0	591	293	308	261
HCM Platoon Ratio	1.00	1.00	1.00	1.00	1.00	1.00	1.00	1.00	1.00	1.00	1.00	1.00
Upstream Filter(I)	1.00	1.00	1.00	0.00	1.00	1.00	1.00	0.00	1.00	1.00	0.00	1.00
Uniform Delay (d), s/veh	52.8	26.3	28.0	0.0	35.6	35.6	31.6	0.0	30.1	47.1	0.0	49.5
Incr Delay (d2), s/veh	13.2	1.0	7.3	0.0	24.5	34.0	12.0	0.0	8.7	0.6	0.0	10.0
Initial Q Delay(d3),s/veh	0.0	0.0	0.0	0.0	0.0	0.0	0.0	0.0	0.0	0.0	0.0	0.0
%ile BackOfQ(50%),veh/ln	1.2	12.1	13.7	0.0	19.5	22.8	16.1	0.0	11.5	0.8	0.0	6.4
Unsig. Movement Delay, s/veh												
LnGrp Delay(d),s/veh	66.0	27.3	35.3	0.0	60.0	69.6	43.6	0.0	38.8	47.7	0.0	59.5
LnGrp LOS	E	C	D	A	E	E	D	A	D	D	A	E
Approach Vol, veh/h		2274			1829			1026				132
Approach Delay, s/veh		29.8			63.4			41.5				56.9
Approach LOS		C			E			D				E
Timer - Assigned Phs		2		4		6	7	8				
Phs Duration (G+Y+Rc), s		45.5		50.9		13.6	7.8	43.1				
Change Period (Y+Rc), s		4.5		4.5		4.5	4.5	4.5				
Max Green Setting (Gmax), s		30.2		48.2		18.1	5.1	38.6				
Max Q Clear Time (g_c+I1), s		33.6		35.4		9.0	4.2	40.3				
Green Ext Time (p_c), s		0.0		10.2		0.2	0.0	0.0				

Intersection Summary

HCM 6th Ctrl Delay	44.5
HCM 6th LOS	D

Notes

User approved volume balancing among the lanes for turning movement.

HCM 6th Signalized Intersection Summary

3: Rancho Viejo & Ortega

08/02/2019



Movement	EBL	EBT	EBR	WBL	WBT	WBR	NBL	NBT	NBR	SBL	SBT	SBR
Lane Configurations	↶	↷	↷	↶	↷	↷	↶	↷	↷	↶	↷	↷
Traffic Volume (veh/h)	236	1061	567	71	1489	419	269	134	58	166	124	109
Future Volume (veh/h)	236	1061	567	71	1489	419	269	134	58	166	124	109
Initial Q (Qb), veh	0	0	0	0	0	0	0	0	0	0	0	0
Ped-Bike Adj(A_pbT)	1.00		1.00	1.00		1.00	1.00		1.00	1.00		1.00
Parking Bus, Adj	1.00	1.00	1.00	1.00	1.00	1.00	1.00	1.00	1.00	1.00	1.00	1.00
Work Zone On Approach		No			No			No			No	
Adj Sat Flow, veh/h/ln	1870	1870	1870	1870	1870	1870	1870	1870	1870	1870	1870	1870
Adj Flow Rate, veh/h	248	1117	597	75	1567	441	319	91	61	140	180	115
Peak Hour Factor	0.95	0.95	0.95	0.95	0.95	0.95	0.95	0.95	0.95	0.95	0.95	0.95
Percent Heavy Veh, %	2	2	2	2	2	2	2	2	2	2	2	2
Cap, veh/h	258	1407	1028	96	1557	483	900	264	177	209	256	155
Arrive On Green	0.14	0.40	0.40	0.05	0.31	0.31	0.25	0.25	0.25	0.12	0.12	0.12
Sat Flow, veh/h	1781	3554	1585	1781	5106	1585	3563	1044	700	1781	2182	1321
Grp Volume(v), veh/h	248	1117	597	75	1567	441	319	0	152	140	153	142
Grp Sat Flow(s),veh/h/ln	1781	1777	1585	1781	1702	1585	1781	0	1744	1781	1870	1633
Q Serve(g_s), s	13.8	27.7	21.2	4.2	30.5	26.8	7.3	0.0	7.1	7.5	7.9	8.4
Cycle Q Clear(g_c), s	13.8	27.7	21.2	4.2	30.5	26.8	7.3	0.0	7.1	7.5	7.9	8.4
Prop In Lane	1.00		1.00	1.00		1.00	1.00		0.40	1.00		0.81
Lane Grp Cap(c), veh/h	258	1407	1028	96	1557	483	900	0	441	209	219	192
V/C Ratio(X)	0.96	0.79	0.58	0.78	1.01	0.91	0.35	0.00	0.34	0.67	0.70	0.74
Avail Cap(c_a), veh/h	258	1407	1028	123	1557	483	900	0	441	321	337	294
HCM Platoon Ratio	1.00	1.00	1.00	1.00	1.00	1.00	1.00	1.00	1.00	1.00	1.00	1.00
Upstream Filter(I)	1.00	1.00	1.00	1.00	1.00	1.00	1.00	0.00	1.00	1.00	1.00	1.00
Uniform Delay (d), s/veh	42.5	26.6	9.9	46.7	34.7	33.5	30.7	0.0	30.6	42.3	42.4	42.7
Incr Delay (d2), s/veh	44.9	3.2	0.8	21.2	24.3	21.6	1.1	0.0	2.1	3.7	4.0	5.6
Initial Q Delay(d3),s/veh	0.0	0.0	0.0	0.0	0.0	0.0	0.0	0.0	0.0	0.0	0.0	0.0
%ile BackOfQ(50%),veh/ln	9.2	11.9	13.5	2.4	15.8	12.9	3.3	0.0	3.2	3.5	3.8	3.7
Unsig. Movement Delay, s/veh												
LnGrp Delay(d),s/veh	87.4	29.8	10.7	67.9	59.1	55.0	31.8	0.0	32.7	46.0	46.4	48.3
LnGrp LOS	F	C	B	E	F	E	C	A	C	D	D	D
Approach Vol, veh/h		1962			2083			471				435
Approach Delay, s/veh		31.3			58.5			32.1				46.9
Approach LOS		C			E			C				D
Timer - Assigned Phs		2	3	4		6	7	8				
Phs Duration (G+Y+Rc), s		29.8	9.9	44.1		16.2	19.0	35.0				
Change Period (Y+Rc), s		4.5	4.5	4.5		4.5	4.5	4.5				
Max Green Setting (Gmax), s		19.0	6.9	38.1		18.0	14.5	30.5				
Max Q Clear Time (g_c+I1), s		9.3	6.2	29.7		10.4	15.8	32.5				
Green Ext Time (p_c), s		1.5	0.0	5.9		1.3	0.0	0.0				

Intersection Summary

HCM 6th Ctrl Delay	44.2
HCM 6th LOS	D

Notes

User approved volume balancing among the lanes for turning movement.

HCM 6th Signalized Intersection Summary

4: La Novia & Ortega

08/02/2019

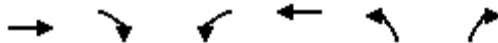

Movement	EBT	EBR	WBL	WBT	NBL	NBR
Lane Configurations	↑↑	↑	↵	↑↑	↵↵	↵
Traffic Volume (veh/h)	1015	238	208	1546	396	230
Future Volume (veh/h)	1015	238	208	1546	396	230
Initial Q (Qb), veh	0	0	0	0	0	0
Ped-Bike Adj(A_pbT)		1.00	1.00		1.00	1.00
Parking Bus, Adj	1.00	1.00	1.00	1.00	1.00	1.00
Work Zone On Approach	No			No	No	
Adj Sat Flow, veh/h/ln	1870	1870	1870	1870	1870	1870
Adj Flow Rate, veh/h	1068	251	219	1627	417	242
Peak Hour Factor	0.95	0.95	0.95	0.95	0.95	0.95
Percent Heavy Veh, %	2	2	2	2	2	2
Cap, veh/h	1200	535	264	1972	1059	486
Arrive On Green	0.34	0.34	0.15	0.56	0.31	0.31
Sat Flow, veh/h	3647	1585	1781	3647	3456	1585
Grp Volume(v), veh/h	1068	251	219	1627	417	242
Grp Sat Flow(s),veh/h/ln	1777	1585	1781	1777	1728	1585
Q Serve(g_s), s	18.5	8.1	7.8	24.4	6.2	8.1
Cycle Q Clear(g_c), s	18.5	8.1	7.8	24.4	6.2	8.1
Prop In Lane		1.00	1.00		1.00	1.00
Lane Grp Cap(c), veh/h	1200	535	264	1972	1059	486
V/C Ratio(X)	0.89	0.47	0.83	0.82	0.39	0.50
Avail Cap(c_a), veh/h	1230	549	288	2050	1059	486
HCM Platoon Ratio	1.00	1.00	1.00	1.00	1.00	1.00
Upstream Filter(I)	1.00	1.00	1.00	1.00	1.00	1.00
Uniform Delay (d), s/veh	20.4	16.9	26.9	11.9	17.8	18.4
Incr Delay (d2), s/veh	8.2	0.6	17.1	2.8	1.1	3.6
Initial Q Delay(d3),s/veh	0.0	0.0	0.0	0.0	0.0	0.0
%ile BackOfQ(50%),veh/ln	8.3	2.8	4.4	8.5	2.4	3.2
Unsig. Movement Delay, s/veh						
LnGrp Delay(d),s/veh	28.6	17.6	44.0	14.7	18.9	22.1
LnGrp LOS	C	B	D	B	B	C
Approach Vol, veh/h	1319			1846	659	
Approach Delay, s/veh	26.5			18.2	20.0	
Approach LOS	C			B	C	
Timer - Assigned Phs		2	3	4		8
Phs Duration (G+Y+Rc), s		24.4	14.1	26.5		40.6
Change Period (Y+Rc), s		4.5	4.5	4.5		4.5
Max Green Setting (Gmax), s		18.5	10.5	22.5		37.5
Max Q Clear Time (g_c+I1), s		10.1	9.8	20.5		26.4
Green Ext Time (p_c), s		1.7	0.0	1.5		8.1
Intersection Summary						
HCM 6th Ctrl Delay			21.4			
HCM 6th LOS			C			

































HCM 6th Signalized Intersection Summary
5: Reata Rd & Ortega Hwy

08/02/2019

Movement	EBL	EBT	EBR	WBL	WBT	WBR	NBL	NBT	NBR	SBL	SBT	SBR
Lane Configurations												
Traffic Volume (veh/h)	57	1221	3	4	1427	24	2	3	0	15	0	153
Future Volume (veh/h)	57	1221	3	4	1427	24	2	3	0	15	0	153
Initial Q (Qb), veh	0	0	0	0	0	0	0	0	0	0	0	0
Ped-Bike Adj(A_pbT)	1.00		1.00	1.00		1.00	1.00		1.00	1.00		1.00
Parking Bus, Adj	1.00	1.00	1.00	1.00	1.00	1.00	1.00	1.00	1.00	1.00	1.00	1.00
Work Zone On Approach		No			No			No			No	
Adj Sat Flow, veh/h/ln	1870	1870	1870	1870	1870	1870	1870	1870	1870	1870	1870	1870
Adj Flow Rate, veh/h	60	1285	3	4	1502	25	2	3	0	16	0	161
Peak Hour Factor	0.95	0.95	0.95	0.95	0.95	0.95	0.95	0.95	0.95	0.95	0.95	0.95
Percent Heavy Veh, %	2	2	2	2	2	2	2	2	2	2	2	2
Cap, veh/h	89	1863	831	10	1704	760	336	503	0	486	0	426
Arrive On Green	0.05	0.52	0.52	0.01	0.48	0.48	0.27	0.27	0.00	0.27	0.00	0.27
Sat Flow, veh/h	1781	3554	1585	1781	3554	1585	1225	1870	0	1414	0	1585
Grp Volume(v), veh/h	60	1285	3	4	1502	25	2	3	0	16	0	161
Grp Sat Flow(s),veh/h/ln	1781	1777	1585	1781	1777	1585	1225	1870	0	1414	0	1585
Q Serve(g_s), s	2.2	18.0	0.1	0.1	25.5	0.6	0.1	0.1	0.0	0.6	0.0	5.5
Cycle Q Clear(g_c), s	2.2	18.0	0.1	0.1	25.5	0.6	5.6	0.1	0.0	0.6	0.0	5.5
Prop In Lane	1.00		1.00	1.00		1.00	1.00		0.00	1.00		1.00
Lane Grp Cap(c), veh/h	89	1863	831	10	1704	760	336	503	0	486	0	426
V/C Ratio(X)	0.67	0.69	0.00	0.42	0.88	0.03	0.01	0.01	0.00	0.03	0.00	0.38
Avail Cap(c_a), veh/h	133	1863	831	133	1778	793	336	503	0	486	0	426
HCM Platoon Ratio	1.00	1.00	1.00	1.00	1.00	1.00	1.00	1.00	1.00	1.00	1.00	1.00
Upstream Filter(I)	1.00	1.00	1.00	1.00	1.00	1.00	1.00	1.00	0.00	1.00	0.00	1.00
Uniform Delay (d), s/veh	31.3	11.9	7.6	33.2	15.7	9.2	22.2	17.9	0.0	18.2	0.0	19.9
Incr Delay (d2), s/veh	8.4	1.1	0.0	26.7	5.4	0.0	0.0	0.0	0.0	0.1	0.0	2.5
Initial Q Delay(d3),s/veh	0.0	0.0	0.0	0.0	0.0	0.0	0.0	0.0	0.0	0.0	0.0	0.0
%ile BackOfQ(50%),veh/ln	1.1	6.3	0.0	0.1	10.1	0.2	0.0	0.0	0.0	0.2	0.0	2.2
Unsig. Movement Delay, s/veh												
LnGrp Delay(d),s/veh	39.6	13.0	7.6	59.9	21.1	9.2	22.2	18.0	0.0	18.3	0.0	22.5
LnGrp LOS	D	B	A	E	C	A	C	B	A	B	A	C
Approach Vol, veh/h		1348			1531			5				177
Approach Delay, s/veh		14.1			21.0			19.7				22.1
Approach LOS		B			C			B				C
Timer - Assigned Phs		2	3	4		6	7	8				
Phs Duration (G+Y+Rc), s		22.5	4.9	39.6		22.5	7.9	36.6				
Change Period (Y+Rc), s		4.5	4.5	4.5		4.5	4.5	4.5				
Max Green Setting (Gmax), s		18.0	5.0	33.5		18.0	5.0	33.5				
Max Q Clear Time (g_c+I1), s		7.6	2.1	20.0		7.5	4.2	27.5				
Green Ext Time (p_c), s		0.0	0.0	7.7		0.7	0.0	4.6				
Intersection Summary												
HCM 6th Ctrl Delay			18.1									
HCM 6th LOS			B									

HCM 6th Signalized Intersection Summary
 6: Av. La Pata/Antonio Pkwy & Ortega Hwy

08/02/2019

												
Movement	EBL	EBT	EBR	WBL	WBT	WBR	NBL	NBT	NBR	SBL	SBT	SBR
Lane Configurations	 	 			 		 	  			  	
Traffic Volume (veh/h)	487	199	385	161	654	291	428	494	40	117	726	568
Future Volume (veh/h)	487	199	385	161	654	291	428	494	40	117	726	568
Initial Q (Qb), veh	0	0	0	0	0	0	0	0	0	0	0	0
Ped-Bike Adj(A_pbT)	1.00		1.00	1.00		1.00	1.00		1.00	1.00		1.00
Parking Bus, Adj	1.00	1.00	1.00	1.00	1.00	1.00	1.00	1.00	1.00	1.00	1.00	1.00
Work Zone On Approach		No			No			No			No	
Adj Sat Flow, veh/h/ln	1870	1870	1870	1870	1870	1870	1870	1870	1870	1870	1870	1870
Adj Flow Rate, veh/h	513	209	405	169	688	306	451	520	42	123	764	598
Peak Hour Factor	0.95	0.95	0.95	0.95	0.95	0.95	0.95	0.95	0.95	0.95	0.95	0.95
Percent Heavy Veh, %	2	2	2	2	2	2	2	2	2	2	2	2
Cap, veh/h	586	975	435	206	784	350	500	1513	470	155	1220	1140
Arrive On Green	0.17	0.27	0.27	0.12	0.22	0.22	0.14	0.30	0.30	0.09	0.24	0.24
Sat Flow, veh/h	3456	3554	1585	1781	3554	1585	3456	5106	1585	1781	5106	2790
Grp Volume(v), veh/h	513	209	405	169	688	306	451	520	42	123	764	598
Grp Sat Flow(s),veh/h/ln	1728	1777	1585	1781	1777	1585	1728	1702	1585	1781	1702	1395
Q Serve(g_s), s	11.5	3.6	19.8	7.4	14.9	14.8	10.2	6.3	1.5	5.4	10.7	12.8
Cycle Q Clear(g_c), s	11.5	3.6	19.8	7.4	14.9	14.8	10.2	6.3	1.5	5.4	10.7	12.8
Prop In Lane	1.00		1.00	1.00		1.00	1.00		1.00	1.00		1.00
Lane Grp Cap(c), veh/h	586	975	435	206	784	350	500	1513	470	155	1220	1140
V/C Ratio(X)	0.87	0.21	0.93	0.82	0.88	0.88	0.90	0.34	0.09	0.79	0.63	0.52
Avail Cap(c_a), veh/h	586	975	435	249	804	359	500	1513	470	193	1220	1140
HCM Platoon Ratio	1.00	1.00	1.00	1.00	1.00	1.00	1.00	1.00	1.00	1.00	1.00	1.00
Upstream Filter(I)	1.00	1.00	1.00	1.00	1.00	1.00	1.00	1.00	1.00	1.00	1.00	1.00
Uniform Delay (d), s/veh	32.2	22.2	28.1	34.3	30.0	29.9	33.5	21.9	20.2	35.6	27.1	17.7
Incr Delay (d2), s/veh	13.8	0.1	26.8	16.3	10.7	20.4	19.6	0.6	0.4	16.4	2.4	1.7
Initial Q Delay(d3),s/veh	0.0	0.0	0.0	0.0	0.0	0.0	0.0	0.0	0.0	0.0	0.0	0.0
%ile BackOfQ(50%),veh/ln	5.8	1.5	10.4	4.0	7.3	7.4	5.5	2.5	0.6	3.0	4.4	4.2
Unsig. Movement Delay, s/veh												
LnGrp Delay(d),s/veh	46.0	22.4	54.9	50.7	40.6	50.3	53.1	22.5	20.6	52.0	29.5	19.4
LnGrp LOS	D	C	D	D	D	D	D	C	C	D	C	B
Approach Vol, veh/h		1127			1163			1013			1485	
Approach Delay, s/veh		44.8			44.7			36.0			27.3	
Approach LOS		D			D			D			C	
Timer - Assigned Phs	1	2	3	4	5	6	7	8				
Phs Duration (G+Y+Rc), s	11.4	28.1	13.7	26.3	16.0	23.5	18.0	22.0				
Change Period (Y+Rc), s	4.5	4.5	4.5	4.5	4.5	4.5	4.5	4.5				
Max Green Setting (Gmax), s	8.6	21.9	11.1	20.4	11.5	19.0	13.5	18.0				
Max Q Clear Time (g_c+I1), s	7.4	8.3	9.4	21.8	12.2	14.8	13.5	16.9				
Green Ext Time (p_c), s	0.0	3.1	0.1	0.0	0.0	2.7	0.0	0.7				
Intersection Summary												
HCM 6th Ctrl Delay			37.5									
HCM 6th LOS			D									

HCM 6th Signalized Intersection Summary
 7: Av. La Pata & Stallion Ridge

08/02/2019



Movement	EBL	EBT	EBR	WBL	WBT	WBR	NBL	NBT	NBR	SBL	SBT	SBR
Lane Configurations	↔↔	↔		↔	↔		↔	↕↔		↔	↕↕↕	↔
Traffic Volume (veh/h)	551	0	109	7	0	19	178	463	4	20	492	819
Future Volume (veh/h)	551	0	109	7	0	19	178	463	4	20	492	819
Initial Q (Qb), veh	0	0	0	0	0	0	0	0	0	0	0	0
Ped-Bike Adj(A_pbT)	1.00		1.00	1.00		1.00	1.00		1.00	1.00		1.00
Parking Bus, Adj	1.00	1.00	1.00	1.00	1.00	1.00	1.00	1.00	1.00	1.00	1.00	1.00
Work Zone On Approach		No			No			No			No	
Adj Sat Flow, veh/h/ln	1870	1870	1870	1870	1870	1870	1870	1870	1870	1870	1870	1870
Adj Flow Rate, veh/h	580	0	115	7	0	20	187	487	4	21	518	0
Peak Hour Factor	0.95	0.95	0.95	0.95	0.95	0.95	0.95	0.95	0.95	0.95	0.95	0.95
Percent Heavy Veh, %	2	2	2	2	2	2	2	2	2	2	2	2
Cap, veh/h	699	0	314	124	0	104	228	1655	14	42	1809	
Arrive On Green	0.20	0.00	0.20	0.07	0.00	0.07	0.13	0.46	0.46	0.02	0.35	0.00
Sat Flow, veh/h	3456	0	1585	1781	0	1585	1781	3612	30	1781	5106	1585
Grp Volume(v), veh/h	580	0	115	7	0	20	187	239	252	21	518	0
Grp Sat Flow(s),veh/h/ln	1728	0	1585	1781	0	1585	1781	1777	1865	1781	1702	1585
Q Serve(g_s), s	11.6	0.0	4.5	0.3	0.0	0.9	7.4	6.1	6.1	0.8	5.2	0.0
Cycle Q Clear(g_c), s	11.6	0.0	4.5	0.3	0.0	0.9	7.4	6.1	6.1	0.8	5.2	0.0
Prop In Lane	1.00		1.00	1.00		1.00	1.00		0.02	1.00		1.00
Lane Grp Cap(c), veh/h	699	0	314	124	0	104	228	814	855	42	1809	
V/C Ratio(X)	0.83	0.00	0.37	0.06	0.00	0.19	0.82	0.29	0.29	0.49	0.29	
Avail Cap(c_a), veh/h	864	0	396	445	0	396	260	814	855	131	1809	
HCM Platoon Ratio	1.00	1.00	1.00	1.00	1.00	1.00	1.00	1.00	1.00	1.00	1.00	1.00
Upstream Filter(I)	1.00	0.00	1.00	1.00	0.00	1.00	1.00	1.00	1.00	1.00	1.00	0.00
Uniform Delay (d), s/veh	27.5	0.0	24.9	31.3	0.0	31.8	30.6	12.2	12.2	34.7	16.7	0.0
Incr Delay (d2), s/veh	5.6	0.0	0.7	0.2	0.0	0.9	16.9	0.9	0.9	8.7	0.4	0.0
Initial Q Delay(d3),s/veh	0.0	0.0	0.0	0.0	0.0	0.0	0.0	0.0	0.0	0.0	0.0	0.0
%ile BackOfQ(50%),veh/ln	5.1	0.0	1.7	0.1	0.0	0.3	4.1	2.4	2.5	0.5	2.0	0.0
Unsig. Movement Delay, s/veh												
LnGrp Delay(d),s/veh	33.1	0.0	25.6	31.5	0.0	32.7	47.4	13.1	13.1	43.4	17.1	0.0
LnGrp LOS	C	A	C	C	A	C	D	B	B	D	B	
Approach Vol, veh/h		695			27			678			539	A
Approach Delay, s/veh		31.9			32.4			22.6			18.1	
Approach LOS		C			C			C			B	
Timer - Assigned Phs	1	2	3	4	5	6	7	8				
Phs Duration (G+Y+Rc), s	6.2	37.5	9.5	18.8	13.7	30.0	19.1	9.2				
Change Period (Y+Rc), s	4.5	4.5	4.5	4.5	4.5	4.5	4.5	4.5				
Max Green Setting (Gmax), s	5.3	30.7	18.0	18.0	10.5	25.5	18.0	18.0				
Max Q Clear Time (g_c+I1), s	2.8	8.1	2.3	6.5	9.4	7.2	13.6	2.9				
Green Ext Time (p_c), s	0.0	2.9	0.0	0.4	0.1	3.3	1.0	0.0				

Intersection Summary

HCM 6th Ctrl Delay	24.8
HCM 6th LOS	C













Notes

Unsignalized Delay for [SBR] is excluded from calculations of the approach delay and intersection delay.

HCM 6th Signalized Intersection Summary

1: Ortega & I-5 SB Off-Ramp

08/02/2019

												
Movement	EBL	EBT	EBR	WBL	WBT	WBR	NBL	NBT	NBR	SBL	SBT	SBR
Lane Configurations		↑↑↑	↗	↖↗	↑↑					↖↗		↖↗
Traffic Volume (veh/h)	0	1084	172	402	708	0	0	0	0	1018	0	746
Future Volume (veh/h)	0	1084	172	402	708	0	0	0	0	1018	0	746
Initial Q (Qb), veh	0	0	0	0	0	0				0	0	0
Ped-Bike Adj(A_pbT)	1.00		1.00	1.00		1.00				1.00		1.00
Parking Bus, Adj	1.00	1.00	1.00	1.00	1.00	1.00				1.00	1.00	1.00
Work Zone On Approach		No			No						No	
Adj Sat Flow, veh/h/ln	0	1870	1870	1870	1870	0				1870	0	1870
Adj Flow Rate, veh/h	0	1141	0	423	745	0				1072	0	785
Peak Hour Factor	0.95	0.95	0.95	0.95	0.95	0.95				0.95	0.95	0.95
Percent Heavy Veh, %	0	2	2	2	2	0				2	0	2
Cap, veh/h	0	1358		505	1711	0				1314	0	1061
Arrive On Green	0.00	0.27	0.00	0.15	0.48	0.00				0.38	0.00	0.38
Sat Flow, veh/h	0	5274	1585	3456	3647	0				3456	0	2790
Grp Volume(v), veh/h	0	1141	0	423	745	0				1072	0	785
Grp Sat Flow(s),veh/h/ln	0	1702	1585	1728	1777	0				1728	0	1395
Q Serve(g_s), s	0.0	13.7	0.0	7.7	8.9	0.0				18.1	0.0	15.8
Cycle Q Clear(g_c), s	0.0	13.7	0.0	7.7	8.9	0.0				18.1	0.0	15.8
Prop In Lane	0.00		1.00	1.00		0.00				1.00		1.00
Lane Grp Cap(c), veh/h	0	1358		505	1711	0				1314	0	1061
V/C Ratio(X)	0.00	0.84		0.84	0.44	0.00				0.82	0.00	0.74
Avail Cap(c_a), veh/h	0	1414		505	1750	0				1314	0	1061
HCM Platoon Ratio	1.00	1.00	1.00	1.00	1.00	1.00				1.00	1.00	1.00
Upstream Filter(I)	0.00	1.00	0.00	1.00	1.00	0.00				1.00	0.00	1.00
Uniform Delay (d), s/veh	0.0	22.5	0.0	27.0	11.1	0.0				18.1	0.0	17.4
Incr Delay (d2), s/veh	0.0	4.6	0.0	11.8	0.2	0.0				4.1	0.0	2.8
Initial Q Delay(d3),s/veh	0.0	0.0	0.0	0.0	0.0	0.0				0.0	0.0	0.0
%ile BackOfQ(50%),veh/ln	0.0	5.7	0.0	3.8	3.1	0.0				7.2	0.0	4.9
Unsig. Movement Delay, s/veh												
LnGrp Delay(d),s/veh	0.0	27.1	0.0	38.8	11.2	0.0				22.2	0.0	20.2
LnGrp LOS	A	C		D	B	A				C	A	C
Approach Vol, veh/h		1141	A		1168						1857	
Approach Delay, s/veh		27.1			21.2						21.4	
Approach LOS		C			C						C	
Timer - Assigned Phs			3	4		6			8			
Phs Duration (G+Y+Rc), s			14.0	21.8		29.2			35.8			
Change Period (Y+Rc), s			4.5	4.5		4.5			4.5			
Max Green Setting (Gmax), s			9.5	18.0		24.0			32.0			
Max Q Clear Time (g_c+I1), s			9.7	15.7		20.1			10.9			
Green Ext Time (p_c), s			0.0	1.6		2.7			5.3			
Intersection Summary												
HCM 6th Ctrl Delay			22.9									
HCM 6th LOS			C									
Notes												
Unsignalized Delay for [EBR] is excluded from calculations of the approach delay and intersection delay.												

HCM 6th Signalized Intersection Summary
 2: I-5 NB Ramps & Ortega

08/02/2019



Movement	EBL	EBT	EBR	WBL	WBT	WBR	NBL	NBT	NBR	SBL	SBT	SBR
Lane Configurations												
Traffic Volume (veh/h)	48	1522	536	0	1820	82	164	18	390	40	0	116
Future Volume (veh/h)	48	1522	536	0	1820	82	164	18	390	40	0	116
Initial Q (Qb), veh	0	0	0	0	0	0	0	0	0	0	0	0
Ped-Bike Adj(A_pbT)	1.00		1.00	1.00		1.00	1.00		1.00	1.00		1.00
Parking Bus, Adj	1.00	1.00	1.00	1.00	1.00	1.00	1.00	1.00	1.00	1.00	1.00	1.00
Work Zone On Approach		No			No			No			No	
Adj Sat Flow, veh/h/ln	1870	1870	1870	0	1870	1870	1870	1870	1870	1870	1870	1870
Adj Flow Rate, veh/h	51	1636	542	0	1916	86	173	183	302	42	0	122
Peak Hour Factor	0.95	0.95	0.95	0.95	0.95	0.95	0.95	0.95	0.95	0.95	0.95	0.95
Percent Heavy Veh, %	2	2	2	0	2	2	2	2	2	2	2	2
Cap, veh/h	67	2625	742	0	1929	86	266	282	476	173	182	154
Arrive On Green	0.04	0.47	0.47	0.00	0.39	0.39	0.30	0.30	0.30	0.10	0.00	0.10
Sat Flow, veh/h	1781	5611	1585	0	5178	224	887	939	1585	1781	1870	1585
Grp Volume(v), veh/h	51	1636	542	0	1301	701	356	0	302	42	0	122
Grp Sat Flow(s),veh/h/ln	1781	1870	1585	0	1702	1830	1826	0	1585	1781	1870	1585
Q Serve(g_s), s	2.8	21.9	27.7	0.0	38.0	38.2	17.0	0.0	16.5	2.2	0.0	7.5
Cycle Q Clear(g_c), s	2.8	21.9	27.7	0.0	38.0	38.2	17.0	0.0	16.5	2.2	0.0	7.5
Prop In Lane	1.00		1.00	0.00		0.12	0.49		1.00	1.00		1.00
Lane Grp Cap(c), veh/h	67	2625	742	0	1311	705	548	0	476	173	182	154
V/C Ratio(X)	0.76	0.62	0.73	0.00	0.99	1.00	0.65	0.00	0.64	0.24	0.00	0.79
Avail Cap(c_a), veh/h	94	2710	766	0	1311	705	548	0	476	322	339	287
HCM Platoon Ratio	1.00	1.00	1.00	1.00	1.00	1.00	1.00	1.00	1.00	1.00	1.00	1.00
Upstream Filter(I)	1.00	1.00	1.00	0.00	1.00	1.00	1.00	0.00	1.00	1.00	0.00	1.00
Uniform Delay (d), s/veh	47.6	20.0	21.5	0.0	30.6	30.7	30.4	0.0	30.3	41.7	0.0	44.2
Incr Delay (d2), s/veh	19.6	0.4	3.5	0.0	23.0	32.7	5.9	0.0	6.3	0.7	0.0	8.8
Initial Q Delay(d3),s/veh	0.0	0.0	0.0	0.0	0.0	0.0	0.0	0.0	0.0	0.0	0.0	0.0
%ile BackOfQ(50%),veh/ln	1.6	9.3	10.5	0.0	19.1	22.5	8.2	0.0	7.0	1.0	0.0	6.8
Unsig. Movement Delay, s/veh												
LnGrp Delay(d),s/veh	67.2	20.4	25.0	0.0	53.6	63.4	36.3	0.0	36.6	42.5	0.0	53.0
LnGrp LOS	E	C	C	A	D	E	D	A	D	D	A	D
Approach Vol, veh/h		2229			2002			658				164
Approach Delay, s/veh		22.6			57.0			36.4				50.3
Approach LOS		C			E			D				D
Timer - Assigned Phs		2		4		6	7	8				
Phs Duration (G+Y+Rc), s		34.5		51.3		14.2	8.3	43.0				
Change Period (Y+Rc), s		4.5		4.5		4.5	4.5	4.5				
Max Green Setting (Gmax), s		20.1		48.3		18.1	5.3	38.5				
Max Q Clear Time (g_c+I1), s		19.0		29.7		9.5	4.8	40.2				
Green Ext Time (p_c), s		0.4		13.5		0.3	0.0	0.0				
Intersection Summary												
HCM 6th Ctrl Delay				38.9								
HCM 6th LOS				D								
Notes												
User approved volume balancing among the lanes for turning movement.												

HCM 6th Signalized Intersection Summary

3: Rancho Viejo & Ortega

08/02/2019



Movement	EBL	EBT	EBR	WBL	WBT	WBR	NBL	NBT	NBR	SBL	SBT	SBR
Lane Configurations	↶	↷	↷	↶	↷	↷	↶	↷	↷	↶	↷	↷
Traffic Volume (veh/h)	161	1440	358	49	1125	214	420	106	97	275	125	277
Future Volume (veh/h)	161	1440	358	49	1125	214	420	106	97	275	125	277
Initial Q (Qb), veh	0	0	0	0	0	0	0	0	0	0	0	0
Ped-Bike Adj(A_pbT)	1.00		1.00	1.00		1.00	1.00		1.00	1.00		1.00
Parking Bus, Adj	1.00	1.00	1.00	1.00	1.00	1.00	1.00	1.00	1.00	1.00	1.00	1.00
Work Zone On Approach		No			No			No			No	
Adj Sat Flow, veh/h/ln	1870	1870	1870	1870	1870	1870	1870	1870	1870	1870	1870	1870
Adj Flow Rate, veh/h	169	1516	377	52	1184	225	442	112	102	238	204	292
Peak Hour Factor	0.95	0.95	0.95	0.95	0.95	0.95	0.95	0.95	0.95	0.95	0.95	0.95
Percent Heavy Veh, %	2	2	2	2	2	2	2	2	2	2	2	2
Cap, veh/h	201	1439	954	68	1687	524	701	177	162	321	337	285
Arrive On Green	0.11	0.41	0.41	0.04	0.33	0.33	0.20	0.20	0.20	0.18	0.18	0.18
Sat Flow, veh/h	1781	3554	1585	1781	5106	1585	3563	902	821	1781	1870	1585
Grp Volume(v), veh/h	169	1516	377	52	1184	225	442	0	214	238	204	292
Grp Sat Flow(s),veh/h/ln	1781	1777	1585	1781	1702	1585	1781	0	1723	1781	1870	1585
Q Serve(g_s), s	9.3	40.5	12.4	2.9	20.2	11.1	11.4	0.0	11.4	12.6	10.0	18.0
Cycle Q Clear(g_c), s	9.3	40.5	12.4	2.9	20.2	11.1	11.4	0.0	11.4	12.6	10.0	18.0
Prop In Lane	1.00		1.00	1.00		1.00	1.00		0.48	1.00		1.00
Lane Grp Cap(c), veh/h	201	1439	954	68	1687	524	701	0	339	321	337	285
V/C Ratio(X)	0.84	1.05	0.40	0.76	0.70	0.43	0.63	0.00	0.63	0.74	0.61	1.02
Avail Cap(c_a), veh/h	237	1439	954	89	1687	524	701	0	339	321	337	285
HCM Platoon Ratio	1.00	1.00	1.00	1.00	1.00	1.00	1.00	1.00	1.00	1.00	1.00	1.00
Upstream Filter(I)	1.00	1.00	1.00	1.00	1.00	1.00	1.00	0.00	1.00	1.00	1.00	1.00
Uniform Delay (d), s/veh	43.5	29.7	10.4	47.6	29.2	26.1	36.8	0.0	36.8	38.8	37.7	41.0
Incr Delay (d2), s/veh	20.3	39.1	0.3	24.2	1.3	0.6	4.3	0.0	8.6	8.9	3.1	59.4
Initial Q Delay(d3),s/veh	0.0	0.0	0.0	0.0	0.0	0.0	0.0	0.0	0.0	0.0	0.0	0.0
%ile BackOfQ(50%),veh/ln	5.2	24.3	6.8	1.7	8.3	4.2	5.3	0.0	5.6	6.3	4.8	11.6
Unsig. Movement Delay, s/veh												
LnGrp Delay(d),s/veh	63.8	68.9	10.7	71.9	30.5	26.7	41.1	0.0	45.5	47.8	40.8	100.4
LnGrp LOS	E	F	B	E	C	C	D	A	D	D	D	F
Approach Vol, veh/h		2062			1461			656			734	
Approach Delay, s/veh		57.8			31.4			42.5			66.8	
Approach LOS		E			C			D			E	
Timer - Assigned Phs		2	3	4		6	7	8				
Phs Duration (G+Y+Rc), s		24.2	8.3	45.0		22.5	15.8	37.5				
Change Period (Y+Rc), s		4.5	4.5	4.5		4.5	4.5	4.5				
Max Green Setting (Gmax), s		18.5	5.0	40.5		18.0	13.3	32.2				
Max Q Clear Time (g_c+I1), s		13.4	4.9	42.5		20.0	11.3	22.2				
Green Ext Time (p_c), s		1.4	0.0	0.0		0.0	0.1	6.1				
Intersection Summary												
HCM 6th Ctrl Delay			49.3									
HCM 6th LOS			D									
Notes												
User approved volume balancing among the lanes for turning movement.												

HCM 6th Signalized Intersection Summary

4: La Novia & Ortega























08/02/2019



Movement	EBT	EBR	WBL	WBT	NBL	NBR
Lane Configurations	↑↑	↑	↓	↑↑	↓	↓
Traffic Volume (veh/h)	1516	176	129	1051	240	167
Future Volume (veh/h)	1516	176	129	1051	240	167
Initial Q (Qb), veh	0	0	0	0	0	0
Ped-Bike Adj(A_pbT)		1.00	1.00		1.00	1.00
Parking Bus, Adj	1.00	1.00	1.00	1.00	1.00	1.00
Work Zone On Approach	No			No	No	
Adj Sat Flow, veh/h/ln	1870	1870	1870	1870	1870	1870
Adj Flow Rate, veh/h	1596	185	136	1106	253	176
Peak Hour Factor	0.95	0.95	0.95	0.95	0.95	0.95
Percent Heavy Veh, %	2	2	2	2	2	2
Cap, veh/h	1727	770	169	2265	864	397
Arrive On Green	0.49	0.49	0.10	0.64	0.25	0.25
Sat Flow, veh/h	3647	1585	1781	3647	3456	1585
Grp Volume(v), veh/h	1596	185	136	1106	253	176
Grp Sat Flow(s),veh/h/ln	1777	1585	1781	1777	1728	1585
Q Serve(g_s), s	33.5	5.4	6.0	13.1	4.7	7.5
Cycle Q Clear(g_c), s	33.5	5.4	6.0	13.1	4.7	7.5
Prop In Lane		1.00	1.00		1.00	1.00
Lane Grp Cap(c), veh/h	1727	770	169	2265	864	397
V/C Ratio(X)	0.92	0.24	0.80	0.49	0.29	0.44
Avail Cap(c_a), veh/h	1755	783	189	2332	864	397
HCM Platoon Ratio	1.00	1.00	1.00	1.00	1.00	1.00
Upstream Filter(I)	1.00	1.00	1.00	1.00	1.00	1.00
Uniform Delay (d), s/veh	19.2	12.0	35.5	7.6	24.3	25.3
Incr Delay (d2), s/veh	8.7	0.2	19.7	0.2	0.9	3.6
Initial Q Delay(d3),s/veh	0.0	0.0	0.0	0.0	0.0	0.0
%ile BackOfQ(50%),veh/ln	14.5	1.8	3.5	4.2	2.0	3.1
Unsig. Movement Delay, s/veh						
LnGrp Delay(d),s/veh	27.9	12.1	55.2	7.8	25.1	28.9
LnGrp LOS	C	B	E	A	C	C
Approach Vol, veh/h	1781			1242	429	
Approach Delay, s/veh	26.2			13.0	26.7	
Approach LOS	C			B	C	
Timer - Assigned Phs		2	3	4		8
Phs Duration (G+Y+Rc), s		24.5	12.1	43.4		55.5
Change Period (Y+Rc), s		4.5	4.5	4.5		4.5
Max Green Setting (Gmax), s		18.5	8.5	39.5		52.5
Max Q Clear Time (g_c+I1), s		9.5	8.0	35.5		15.1
Green Ext Time (p_c), s		1.1	0.0	3.4		10.4
Intersection Summary						
HCM 6th Ctrl Delay			21.5			
HCM 6th LOS			C			

































HCM 6th Signalized Intersection Summary
5: Reata Rd & Ortega Hwy

08/02/2019

												
Movement	EBL	EBT	EBR	WBL	WBT	WBR	NBL	NBT	NBR	SBL	SBT	SBR
Lane Configurations												
Traffic Volume (veh/h)	81	1525	3	10	1026	14	2	0	4	29	0	96
Future Volume (veh/h)	81	1525	3	10	1026	14	2	0	4	29	0	96
Initial Q (Qb), veh	0	0	0	0	0	0	0	0	0	0	0	0
Ped-Bike Adj(A_pbT)	1.00		1.00	1.00		1.00	1.00		1.00	1.00		1.00
Parking Bus, Adj	1.00	1.00	1.00	1.00	1.00	1.00	1.00	1.00	1.00	1.00	1.00	1.00
Work Zone On Approach		No			No			No			No	
Adj Sat Flow, veh/h/ln	1870	1870	1870	1870	1870	1870	1870	1870	1870	1870	1870	1870
Adj Flow Rate, veh/h	85	1605	3	11	1080	15	2	0	4	31	0	101
Peak Hour Factor	0.95	0.95	0.95	0.95	0.95	0.95	0.95	0.95	0.95	0.95	0.95	0.95
Percent Heavy Veh, %	2	2	2	2	2	2	2	2	2	2	2	2
Cap, veh/h	109	1782	795	25	1614	720	405	0	439	499	0	439
Arrive On Green	0.06	0.50	0.50	0.01	0.45	0.45	0.28	0.00	0.28	0.28	0.00	0.28
Sat Flow, veh/h	1781	3554	1585	1781	3554	1585	1294	0	1585	1412	0	1585
Grp Volume(v), veh/h	85	1605	3	11	1080	15	2	0	4	31	0	101
Grp Sat Flow(s),veh/h/ln	1781	1777	1585	1781	1777	1585	1294	0	1585	1412	0	1585
Q Serve(g_s), s	3.1	26.7	0.1	0.4	15.5	0.3	0.1	0.0	0.1	1.1	0.0	3.2
Cycle Q Clear(g_c), s	3.1	26.7	0.1	0.4	15.5	0.3	3.3	0.0	0.1	1.2	0.0	3.2
Prop In Lane	1.00		1.00	1.00		1.00	1.00		1.00	1.00		1.00
Lane Grp Cap(c), veh/h	109	1782	795	25	1614	720	405	0	439	499	0	439
V/C Ratio(X)	0.78	0.90	0.00	0.45	0.67	0.02	0.00	0.00	0.01	0.06	0.00	0.23
Avail Cap(c_a), veh/h	167	1832	817	137	1772	790	405	0	439	499	0	439
HCM Platoon Ratio	1.00	1.00	1.00	1.00	1.00	1.00	1.00	1.00	1.00	1.00	1.00	1.00
Upstream Filter(I)	1.00	1.00	1.00	1.00	1.00	1.00	1.00	0.00	1.00	1.00	0.00	1.00
Uniform Delay (d), s/veh	30.1	14.7	8.1	31.8	13.9	9.8	19.4	0.0	17.0	17.5	0.0	18.1
Incr Delay (d2), s/veh	11.9	6.4	0.0	12.1	0.9	0.0	0.0	0.0	0.0	0.2	0.0	1.2
Initial Q Delay(d3),s/veh	0.0	0.0	0.0	0.0	0.0	0.0	0.0	0.0	0.0	0.0	0.0	0.0
%ile BackOfQ(50%),veh/ln	1.6	10.6	0.0	0.2	5.6	0.1	0.0	0.0	0.0	0.4	0.0	1.2
Unsig. Movement Delay, s/veh												
LnGrp Delay(d),s/veh	42.0	21.2	8.1	43.9	14.8	9.8	19.4	0.0	17.1	17.7	0.0	19.4
LnGrp LOS	D	C	A	D	B	A	B	A	B	B	A	B
Approach Vol, veh/h		1693			1106			6				132
Approach Delay, s/veh		22.2			15.0			17.9				19.0
Approach LOS		C			B			B				B
Timer - Assigned Phs		2	3	4		6	7	8				
Phs Duration (G+Y+Rc), s		22.5	5.4	37.1		22.5	8.5	34.0				
Change Period (Y+Rc), s		4.5	4.5	4.5		4.5	4.5	4.5				
Max Green Setting (Gmax), s		18.0	5.0	33.5		18.0	6.1	32.4				
Max Q Clear Time (g_c+I1), s		5.3	2.4	28.7		5.2	5.1	17.5				
Green Ext Time (p_c), s		0.0	0.0	3.9		0.5	0.0	6.9				
Intersection Summary												
HCM 6th Ctrl Delay				19.3								
HCM 6th LOS				B								

HCM 6th Signalized Intersection Summary
 6: Av. La Pata/Antonio Pkwy & Ortega Hwy

08/02/2019

												
Movement	EBL	EBT	EBR	WBL	WBT	WBR	NBL	NBT	NBR	SBL	SBT	SBR
Lane Configurations	 	 			 		 	  			  	 
Traffic Volume (veh/h)	514	832	223	73	293	109	303	528	127	282	442	529
Future Volume (veh/h)	514	832	223	73	293	109	303	528	127	282	442	529
Initial Q (Qb), veh	0	0	0	0	0	0	0	0	0	0	0	0
Ped-Bike Adj(A_pbT)	1.00		1.00	1.00		1.00	1.00		1.00	1.00		1.00
Parking Bus, Adj	1.00	1.00	1.00	1.00	1.00	1.00	1.00	1.00	1.00	1.00	1.00	1.00
Work Zone On Approach		No			No			No			No	
Adj Sat Flow, veh/h/ln	1870	1870	1870	1870	1870	1870	1870	1870	1870	1870	1870	1870
Adj Flow Rate, veh/h	541	876	235	77	308	115	319	556	134	297	465	557
Peak Hour Factor	0.95	0.95	0.95	0.95	0.95	0.95	0.95	0.95	0.95	0.95	0.95	0.95
Percent Heavy Veh, %	2	2	2	2	2	2	2	2	2	2	2	2
Cap, veh/h	630	1068	477	99	618	276	415	1190	369	338	1547	1354
Arrive On Green	0.18	0.30	0.30	0.06	0.17	0.17	0.12	0.23	0.23	0.19	0.30	0.30
Sat Flow, veh/h	3456	3554	1585	1781	3554	1585	3456	5106	1585	1781	5106	2790
Grp Volume(v), veh/h	541	876	235	77	308	115	319	556	134	297	465	557
Grp Sat Flow(s),veh/h/ln	1728	1777	1585	1781	1777	1585	1728	1702	1585	1781	1702	1395
Q Serve(g_s), s	12.4	18.7	9.9	3.5	6.4	5.3	7.3	7.6	5.8	13.2	5.7	10.5
Cycle Q Clear(g_c), s	12.4	18.7	9.9	3.5	6.4	5.3	7.3	7.6	5.8	13.2	5.7	10.5
Prop In Lane	1.00		1.00	1.00		1.00	1.00		1.00	1.00		1.00
Lane Grp Cap(c), veh/h	630	1068	477	99	618	276	415	1190	369	338	1547	1354
V/C Ratio(X)	0.86	0.82	0.49	0.78	0.50	0.42	0.77	0.47	0.36	0.88	0.30	0.41
Avail Cap(c_a), veh/h	699	1216	542	144	784	350	598	1190	369	404	1547	1354
HCM Platoon Ratio	1.00	1.00	1.00	1.00	1.00	1.00	1.00	1.00	1.00	1.00	1.00	1.00
Upstream Filter(I)	1.00	1.00	1.00	1.00	1.00	1.00	1.00	1.00	1.00	1.00	1.00	1.00
Uniform Delay (d), s/veh	32.3	26.5	23.4	38.0	30.5	30.0	34.8	26.9	26.2	32.1	21.8	13.5
Incr Delay (d2), s/veh	9.7	4.1	0.8	14.9	0.6	1.0	3.8	1.3	2.7	17.0	0.5	0.9
Initial Q Delay(d3),s/veh	0.0	0.0	0.0	0.0	0.0	0.0	0.0	0.0	0.0	0.0	0.0	0.0
%ile BackOfQ(50%),veh/ln	5.9	8.1	3.7	1.9	2.7	2.0	3.2	3.2	2.4	7.1	2.3	3.2
Unsig. Movement Delay, s/veh												
LnGrp Delay(d),s/veh	42.0	30.6	24.2	52.9	31.1	31.0	38.5	28.2	29.0	49.1	22.3	14.4
LnGrp LOS	D	C	C	D	C	C	D	C	C	D	C	B
Approach Vol, veh/h		1652			500			1009			1319	
Approach Delay, s/veh		33.4			34.4			31.6			25.0	
Approach LOS		C			C			C			C	
Timer - Assigned Phs	1	2	3	4	5	6	7	8				
Phs Duration (G+Y+Rc), s	20.0	23.5	9.0	29.0	14.3	29.2	19.4	18.7				
Change Period (Y+Rc), s	4.5	4.5	4.5	4.5	4.5	4.5	4.5	4.5				
Max Green Setting (Gmax), s	18.5	19.0	6.6	27.9	14.1	23.4	16.5	18.0				
Max Q Clear Time (g_c+I1), s	15.2	9.6	5.5	20.7	9.3	12.5	14.4	8.4				
Green Ext Time (p_c), s	0.3	2.9	0.0	3.9	0.5	4.2	0.5	1.6				
Intersection Summary												
HCM 6th Ctrl Delay			30.6									
HCM 6th LOS			C									

HCM 6th Signalized Intersection Summary
 7: Av. La Pata & Stallion Ridge

08/02/2019



Movement	EBL	EBT	EBR	WBL	WBT	WBR	NBL	NBT	NBR	SBL	SBT	SBR
Lane Configurations	↔↔	↔		↔	↔		↔	↕↔		↔	↕↕↕	↔
Traffic Volume (veh/h)	159	0	46	4	0	16	31	667	1	9	492	268
Future Volume (veh/h)	159	0	46	4	0	16	31	667	1	9	492	268
Initial Q (Qb), veh	0	0	0	0	0	0	0	0	0	0	0	0
Ped-Bike Adj(A_pbT)	1.00		1.00	1.00		1.00	1.00		1.00	1.00		1.00
Parking Bus, Adj	1.00	1.00	1.00	1.00	1.00	1.00	1.00	1.00	1.00	1.00	1.00	1.00
Work Zone On Approach		No			No			No			No	
Adj Sat Flow, veh/h/ln	1870	1870	1870	1870	1870	1870	1870	1870	1870	1870	1870	1870
Adj Flow Rate, veh/h	167	0	48	4	0	17	33	702	1	9	518	0
Peak Hour Factor	0.95	0.95	0.95	0.95	0.95	0.95	0.95	0.95	0.95	0.95	0.95	0.95
Percent Heavy Veh, %	2	2	2	2	2	2	2	2	2	2	2	2
Cap, veh/h	332	0	153	166	0	149	66	1583	2	21	2092	
Arrive On Green	0.10	0.00	0.10	0.09	0.00	0.09	0.04	0.43	0.43	0.01	0.41	0.00
Sat Flow, veh/h	3456	0	1585	1781	0	1585	1781	3641	5	1781	5106	1585
Grp Volume(v), veh/h	167	0	48	4	0	17	33	343	360	9	518	0
Grp Sat Flow(s),veh/h/ln	1728	0	1585	1781	0	1585	1781	1777	1869	1781	1702	1585
Q Serve(g_s), s	2.3	0.0	1.4	0.1	0.0	0.5	0.9	6.7	6.7	0.2	3.3	0.0
Cycle Q Clear(g_c), s	2.3	0.0	1.4	0.1	0.0	0.5	0.9	6.7	6.7	0.2	3.3	0.0
Prop In Lane	1.00		1.00	1.00		1.00	1.00		0.00	1.00		1.00
Lane Grp Cap(c), veh/h	332	0	153	166	0	149	66	773	813	21	2092	
V/C Ratio(X)	0.50	0.00	0.31	0.02	0.00	0.11	0.50	0.44	0.44	0.43	0.25	
Avail Cap(c_a), veh/h	1256	0	576	647	0	576	205	773	813	180	2092	
HCM Platoon Ratio	1.00	1.00	1.00	1.00	1.00	1.00	1.00	1.00	1.00	1.00	1.00	1.00
Upstream Filter(I)	1.00	0.00	1.00	1.00	0.00	1.00	1.00	1.00	1.00	1.00	1.00	0.00
Uniform Delay (d), s/veh	21.3	0.0	20.8	20.4	0.0	20.5	23.4	9.8	9.8	24.3	9.6	0.0
Incr Delay (d2), s/veh	1.2	0.0	1.2	0.1	0.0	0.3	5.8	1.8	1.8	13.3	0.3	0.0
Initial Q Delay(d3),s/veh	0.0	0.0	0.0	0.0	0.0	0.0	0.0	0.0	0.0	0.0	0.0	0.0
%ile BackOfQ(50%),veh/ln	0.9	0.0	0.5	0.0	0.0	0.2	0.5	2.5	2.6	0.2	1.1	0.0
Unsig. Movement Delay, s/veh												
LnGrp Delay(d),s/veh	22.5	0.0	22.0	20.5	0.0	20.9	29.3	11.6	11.6	37.6	9.9	0.0
LnGrp LOS	C	A	C	C	A	C	C	B	B	D	A	
Approach Vol, veh/h		215			21			736			527	A
Approach Delay, s/veh		22.4			20.8			12.4			10.4	
Approach LOS		C			C			B			B	
Timer - Assigned Phs	1	2	3	4	5	6	7	8				
Phs Duration (G+Y+Rc), s	5.1	26.0	9.1	9.3	6.3	24.8	9.3	9.2				
Change Period (Y+Rc), s	4.5	4.5	4.5	4.5	4.5	4.5	4.5	4.5				
Max Green Setting (Gmax), s	5.0	21.0	18.0	18.0	5.7	20.3	18.0	18.0				
Max Q Clear Time (g_c+I1), s	2.2	8.7	2.1	3.4	2.9	5.3	4.3	2.5				
Green Ext Time (p_c), s	0.0	3.5	0.0	0.1	0.0	3.1	0.4	0.0				

Intersection Summary

HCM 6th Ctrl Delay	13.2
HCM 6th LOS	B













Notes

Unsignalized Delay for [SBR] is excluded from calculations of the approach delay and intersection delay.

HCM 6th Signalized Intersection Summary

1: Ortega & I-5 SB Off-Ramp

08/02/2019

												
Movement	EBL	EBT	EBR	WBL	WBT	WBR	NBL	NBT	NBR	SBL	SBT	SBR
Lane Configurations		↑↑↑	↑	↑↑	↑↑					↑↑		↑↑
Traffic Volume (veh/h)	0	1162	194	309	652	0	0	0	0	870	0	936
Future Volume (veh/h)	0	1162	194	309	652	0	0	0	0	870	0	936
Initial Q (Qb), veh	0	0	0	0	0	0				0	0	0
Ped-Bike Adj(A_pbT)	1.00		1.00	1.00		1.00				1.00		1.00
Parking Bus, Adj	1.00	1.00	1.00	1.00	1.00	1.00				1.00	1.00	1.00
Work Zone On Approach		No			No						No	
Adj Sat Flow, veh/h/ln	0	1870	1870	1870	1870	0				1870	0	1870
Adj Flow Rate, veh/h	0	1223	0	325	686	0				916	0	985
Peak Hour Factor	0.95	0.95	0.95	0.95	0.95	0.95				0.95	0.95	0.95
Percent Heavy Veh, %	0	2	2	2	2	0				2	0	2
Cap, veh/h	0	1470		428	1729	0				1256	0	1014
Arrive On Green	0.00	0.29	0.00	0.12	0.49	0.00				0.36	0.00	0.36
Sat Flow, veh/h	0	5274	1585	3456	3647	0				3456	0	2790
Grp Volume(v), veh/h	0	1223	0	325	686	0				916	0	985
Grp Sat Flow(s),veh/h/ln	0	1702	1585	1728	1777	0				1728	0	1395
Q Serve(g_s), s	0.0	13.5	0.0	5.5	7.4	0.0				13.8	0.0	20.8
Cycle Q Clear(g_c), s	0.0	13.5	0.0	5.5	7.4	0.0				13.8	0.0	20.8
Prop In Lane	0.00		1.00	1.00		0.00				1.00		1.00
Lane Grp Cap(c), veh/h	0	1470		428	1729	0				1256	0	1014
V/C Ratio(X)	0.00	0.83		0.76	0.40	0.00				0.73	0.00	0.97
Avail Cap(c_a), veh/h	0	1532		432	1777	0				1256	0	1014
HCM Platoon Ratio	1.00	1.00	1.00	1.00	1.00	1.00				1.00	1.00	1.00
Upstream Filter(I)	0.00	1.00	0.00	1.00	1.00	0.00				1.00	0.00	1.00
Uniform Delay (d), s/veh	0.0	20.0	0.0	25.4	9.8	0.0				16.5	0.0	18.8
Incr Delay (d2), s/veh	0.0	3.9	0.0	7.6	0.1	0.0				2.2	0.0	21.6
Initial Q Delay(d3),s/veh	0.0	0.0	0.0	0.0	0.0	0.0				0.0	0.0	0.0
%ile BackOfQ(50%),veh/ln	0.0	5.4	0.0	2.6	2.4	0.0				5.2	0.0	8.9
Unsig. Movement Delay, s/veh												
LnGrp Delay(d),s/veh	0.0	24.0	0.0	33.0	9.9	0.0				18.7	0.0	40.4
LnGrp LOS	A	C		C	A	A				B	A	D
Approach Vol, veh/h		1223	A		1011						1901	
Approach Delay, s/veh		24.0			17.4						30.0	
Approach LOS		C			B						C	
Timer - Assigned Phs			3	4		6		8				
Phs Duration (G+Y+Rc), s			11.9	21.8		26.3		33.7				
Change Period (Y+Rc), s			4.5	4.5		4.5		4.5				
Max Green Setting (Gmax), s			7.5	18.0		21.0		30.0				
Max Q Clear Time (g_c+I1), s			7.5	15.5		22.8		9.4				
Green Ext Time (p_c), s			0.0	1.8		0.0		4.8				
Intersection Summary												
HCM 6th Ctrl Delay			25.1									
HCM 6th LOS			C									
Notes												
Unsignalized Delay for [EBR] is excluded from calculations of the approach delay and intersection delay.												

HCM 6th Signalized Intersection Summary
 2: I-5 NB Ramps & Ortega

08/02/2019



Movement	EBL	EBT	EBR	WBL	WBT	WBR	NBL	NBT	NBR	SBL	SBT	SBR
Lane Configurations												
Traffic Volume (veh/h)	34	1452	622	0	1683	58	144	26	679	28	0	98
Future Volume (veh/h)	34	1452	622	0	1683	58	144	26	679	28	0	98
Initial Q (Qb), veh	0	0	0	0	0	0	0	0	0	0	0	0
Ped-Bike Adj(A_pbT)	1.00		1.00	1.00		1.00	1.00		1.00	1.00		1.00
Parking Bus, Adj	1.00	1.00	1.00	1.00	1.00	1.00	1.00	1.00	1.00	1.00	1.00	1.00
Work Zone On Approach		No			No			No			No	
Adj Sat Flow, veh/h/ln	1870	1870	1870	0	1870	1870	1870	1870	1870	1870	1870	1870
Adj Flow Rate, veh/h	36	1692	546	0	1772	61	152	429	447	29	0	103
Peak Hour Factor	0.95	0.95	0.95	0.95	0.95	0.95	0.95	0.95	0.95	0.95	0.95	0.95
Percent Heavy Veh, %	2	2	2	0	2	2	2	2	2	2	2	2
Cap, veh/h	54	2369	669	0	1779	61	180	508	591	147	154	131
Arrive On Green	0.03	0.42	0.42	0.00	0.35	0.35	0.37	0.37	0.37	0.08	0.00	0.08
Sat Flow, veh/h	1781	5611	1585	0	5237	174	483	1363	1585	1781	1870	1585
Grp Volume(v), veh/h	36	1692	546	0	1190	643	581	0	447	29	0	103
Grp Sat Flow(s),veh/h/ln	1781	1870	1585	0	1702	1839	1846	0	1585	1781	1870	1585
Q Serve(g_s), s	2.2	27.4	33.4	0.0	38.4	38.4	31.7	0.0	27.1	1.7	0.0	7.0
Cycle Q Clear(g_c), s	2.2	27.4	33.4	0.0	38.4	38.4	31.7	0.0	27.1	1.7	0.0	7.0
Prop In Lane	1.00		1.00	0.00		0.09	0.26		1.00	1.00		1.00
Lane Grp Cap(c), veh/h	54	2369	669	0	1195	645	688	0	591	147	154	131
V/C Ratio(X)	0.67	0.71	0.82	0.00	1.00	1.00	0.84	0.00	0.76	0.20	0.00	0.79
Avail Cap(c_a), veh/h	83	2459	695	0	1195	645	688	0	591	293	308	261
HCM Platoon Ratio	1.00	1.00	1.00	1.00	1.00	1.00	1.00	1.00	1.00	1.00	1.00	1.00
Upstream Filter(l)	1.00	1.00	1.00	0.00	1.00	1.00	1.00	0.00	1.00	1.00	0.00	1.00
Uniform Delay (d), s/veh	52.8	26.3	28.0	0.0	35.6	35.6	31.6	0.0	30.1	47.1	0.0	49.5
Incr Delay (d2), s/veh	13.2	1.0	7.3	0.0	25.0	34.6	12.1	0.0	8.8	0.6	0.0	10.0
Initial Q Delay(d3),s/veh	0.0	0.0	0.0	0.0	0.0	0.0	0.0	0.0	0.0	0.0	0.0	0.0
%ile BackOfQ(50%),veh/ln	1.2	12.1	13.7	0.0	19.6	23.0	16.1	0.0	11.6	0.8	0.0	6.4
Unsig. Movement Delay, s/veh												
LnGrp Delay(d),s/veh	66.0	27.3	35.3	0.0	60.6	70.3	43.7	0.0	38.9	47.7	0.0	59.5
LnGrp LOS	E	C	D	A	E	E	D	A	D	D	A	E
Approach Vol, veh/h		2274			1833			1028				132
Approach Delay, s/veh		29.8			64.0			41.6				56.9
Approach LOS		C			E			D				E
Timer - Assigned Phs		2		4		6	7	8				
Phs Duration (G+Y+Rc), s		45.5		50.9		13.6	7.8	43.1				
Change Period (Y+Rc), s		4.5		4.5		4.5	4.5	4.5				
Max Green Setting (Gmax), s		30.2		48.2		18.1	5.1	38.6				
Max Q Clear Time (g_c+I1), s		33.7		35.4		9.0	4.2	40.4				
Green Ext Time (p_c), s		0.0		10.2		0.2	0.0	0.0				

Intersection Summary

HCM 6th Ctrl Delay	44.7
HCM 6th LOS	D

Notes

User approved volume balancing among the lanes for turning movement.

HCM 6th Signalized Intersection Summary

3: Rancho Viejo & Ortega

08/02/2019



Movement	EBL	EBT	EBR	WBL	WBT	WBR	NBL	NBT	NBR	SBL	SBT	SBR
Lane Configurations	↶	↷	↷	↶	↷	↷	↶	↷	↷	↶	↷	↷
Traffic Volume (veh/h)	236	1064	567	71	1492	419	269	134	58	166	124	109
Future Volume (veh/h)	236	1064	567	71	1492	419	269	134	58	166	124	109
Initial Q (Qb), veh	0	0	0	0	0	0	0	0	0	0	0	0
Ped-Bike Adj(A_pbT)	1.00		1.00	1.00		1.00	1.00		1.00	1.00		1.00
Parking Bus, Adj	1.00	1.00	1.00	1.00	1.00	1.00	1.00	1.00	1.00	1.00	1.00	1.00
Work Zone On Approach		No			No			No			No	
Adj Sat Flow, veh/h/ln	1870	1870	1870	1870	1870	1870	1870	1870	1870	1870	1870	1870
Adj Flow Rate, veh/h	248	1120	597	75	1571	441	319	91	61	140	180	115
Peak Hour Factor	0.95	0.95	0.95	0.95	0.95	0.95	0.95	0.95	0.95	0.95	0.95	0.95
Percent Heavy Veh, %	2	2	2	2	2	2	2	2	2	2	2	2
Cap, veh/h	258	1407	1028	96	1557	483	900	264	177	209	256	155
Arrive On Green	0.14	0.40	0.40	0.05	0.31	0.31	0.25	0.25	0.25	0.12	0.12	0.12
Sat Flow, veh/h	1781	3554	1585	1781	5106	1585	3563	1044	700	1781	2182	1321
Grp Volume(v), veh/h	248	1120	597	75	1571	441	319	0	152	140	153	142
Grp Sat Flow(s),veh/h/ln	1781	1777	1585	1781	1702	1585	1781	0	1744	1781	1870	1633
Q Serve(g_s), s	13.8	27.8	21.2	4.2	30.5	26.8	7.3	0.0	7.1	7.5	7.9	8.4
Cycle Q Clear(g_c), s	13.8	27.8	21.2	4.2	30.5	26.8	7.3	0.0	7.1	7.5	7.9	8.4
Prop In Lane	1.00		1.00	1.00		1.00	1.00		0.40	1.00		0.81
Lane Grp Cap(c), veh/h	258	1407	1028	96	1557	483	900	0	441	209	219	192
V/C Ratio(X)	0.96	0.80	0.58	0.78	1.01	0.91	0.35	0.00	0.34	0.67	0.70	0.74
Avail Cap(c_a), veh/h	258	1407	1028	123	1557	483	900	0	441	321	337	294
HCM Platoon Ratio	1.00	1.00	1.00	1.00	1.00	1.00	1.00	1.00	1.00	1.00	1.00	1.00
Upstream Filter(I)	1.00	1.00	1.00	1.00	1.00	1.00	1.00	0.00	1.00	1.00	1.00	1.00
Uniform Delay (d), s/veh	42.5	26.6	9.9	46.7	34.7	33.5	30.7	0.0	30.6	42.3	42.4	42.7
Incr Delay (d2), s/veh	44.9	3.3	0.8	21.2	25.0	21.6	1.1	0.0	2.1	3.7	4.0	5.6
Initial Q Delay(d3),s/veh	0.0	0.0	0.0	0.0	0.0	0.0	0.0	0.0	0.0	0.0	0.0	0.0
%ile BackOfQ(50%),veh/ln	9.2	12.0	13.5	2.4	15.9	12.9	3.3	0.0	3.2	3.5	3.8	3.7
Unsig. Movement Delay, s/veh												
LnGrp Delay(d),s/veh	87.4	29.9	10.7	67.9	59.7	55.0	31.8	0.0	32.7	46.0	46.4	48.3
LnGrp LOS	F	C	B	E	F	E	C	A	C	D	D	D
Approach Vol, veh/h		1965			2087			471				435
Approach Delay, s/veh		31.3			59.0			32.1				46.9
Approach LOS		C			E			C				D
Timer - Assigned Phs		2	3	4		6	7	8				
Phs Duration (G+Y+Rc), s		29.8	9.9	44.1		16.2	19.0	35.0				
Change Period (Y+Rc), s		4.5	4.5	4.5		4.5	4.5	4.5				
Max Green Setting (Gmax), s		19.0	6.9	38.1		18.0	14.5	30.5				
Max Q Clear Time (g_c+I1), s		9.3	6.2	29.8		10.4	15.8	32.5				
Green Ext Time (p_c), s		1.5	0.0	5.8		1.3	0.0	0.0				

Intersection Summary

HCM 6th Ctrl Delay	44.4
HCM 6th LOS	D

Notes

User approved volume balancing among the lanes for turning movement.

HCM 6th Signalized Intersection Summary

4: La Novia & Ortega



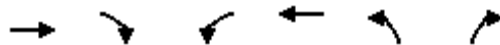



















08/02/2019



Movement	EBT	EBR	WBL	WBT	NBL	NBR
Lane Configurations	↑↑	↑	↵	↑↑	↵↵	↵
Traffic Volume (veh/h)	1018	238	208	1549	396	230
Future Volume (veh/h)	1018	238	208	1549	396	230
Initial Q (Qb), veh	0	0	0	0	0	0
Ped-Bike Adj(A_pbT)		1.00	1.00		1.00	1.00
Parking Bus, Adj	1.00	1.00	1.00	1.00	1.00	1.00
Work Zone On Approach	No			No	No	
Adj Sat Flow, veh/h/ln	1870	1870	1870	1870	1870	1870
Adj Flow Rate, veh/h	1072	251	219	1631	417	242
Peak Hour Factor	0.95	0.95	0.95	0.95	0.95	0.95
Percent Heavy Veh, %	2	2	2	2	2	2
Cap, veh/h	1202	536	264	1974	1058	485
Arrive On Green	0.34	0.34	0.15	0.56	0.31	0.31
Sat Flow, veh/h	3647	1585	1781	3647	3456	1585
Grp Volume(v), veh/h	1072	251	219	1631	417	242
Grp Sat Flow(s),veh/h/ln	1777	1585	1781	1777	1728	1585
Q Serve(g_s), s	18.6	8.1	7.8	24.5	6.2	8.1
Cycle Q Clear(g_c), s	18.6	8.1	7.8	24.5	6.2	8.1
Prop In Lane		1.00	1.00		1.00	1.00
Lane Grp Cap(c), veh/h	1202	536	264	1974	1058	485
V/C Ratio(X)	0.89	0.47	0.83	0.83	0.39	0.50
Avail Cap(c_a), veh/h	1230	549	288	2050	1058	485
HCM Platoon Ratio	1.00	1.00	1.00	1.00	1.00	1.00
Upstream Filter(I)	1.00	1.00	1.00	1.00	1.00	1.00
Uniform Delay (d), s/veh	20.4	16.9	26.9	11.9	17.8	18.5
Incr Delay (d2), s/veh	8.4	0.6	17.1	2.8	1.1	3.6
Initial Q Delay(d3),s/veh	0.0	0.0	0.0	0.0	0.0	0.0
%ile BackOfQ(50%),veh/ln	8.4	2.8	4.4	8.5	2.4	3.2
Unsig. Movement Delay, s/veh						
LnGrp Delay(d),s/veh	28.8	17.5	44.0	14.7	18.9	22.1
LnGrp LOS	C	B	D	B	B	C
Approach Vol, veh/h	1323			1850	659	
Approach Delay, s/veh	26.7			18.2	20.1	
Approach LOS	C			B	C	
Timer - Assigned Phs		2	3	4		8
Phs Duration (G+Y+Rc), s		24.4	14.1	26.5		40.6
Change Period (Y+Rc), s		4.5	4.5	4.5		4.5
Max Green Setting (Gmax), s		18.5	10.5	22.5		37.5
Max Q Clear Time (g_c+I1), s		10.1	9.8	20.6		26.5
Green Ext Time (p_c), s		1.7	0.0	1.4		8.1
Intersection Summary						
HCM 6th Ctrl Delay			21.4			
HCM 6th LOS			C			

































HCM 6th Signalized Intersection Summary
5: Reata Rd & Ortega Hwy

08/02/2019

												
Movement	EBL	EBT	EBR	WBL	WBT	WBR	NBL	NBT	NBR	SBL	SBT	SBR
Lane Configurations												
Traffic Volume (veh/h)	57	1224	3	4	1430	24	2	3	0	15	0	153
Future Volume (veh/h)	57	1224	3	4	1430	24	2	3	0	15	0	153
Initial Q (Qb), veh	0	0	0	0	0	0	0	0	0	0	0	0
Ped-Bike Adj(A_pbT)	1.00		1.00	1.00		1.00	1.00		1.00	1.00		1.00
Parking Bus, Adj	1.00	1.00	1.00	1.00	1.00	1.00	1.00	1.00	1.00	1.00	1.00	1.00
Work Zone On Approach		No			No			No			No	
Adj Sat Flow, veh/h/ln	1870	1870	1870	1870	1870	1870	1870	1870	1870	1870	1870	1870
Adj Flow Rate, veh/h	60	1288	3	4	1505	25	2	3	0	16	0	161
Peak Hour Factor	0.95	0.95	0.95	0.95	0.95	0.95	0.95	0.95	0.95	0.95	0.95	0.95
Percent Heavy Veh, %	2	2	2	2	2	2	2	2	2	2	2	2
Cap, veh/h	89	1864	831	10	1704	760	335	502	0	486	0	426
Arrive On Green	0.05	0.52	0.52	0.01	0.48	0.48	0.27	0.27	0.00	0.27	0.00	0.27
Sat Flow, veh/h	1781	3554	1585	1781	3554	1585	1225	1870	0	1414	0	1585
Grp Volume(v), veh/h	60	1288	3	4	1505	25	2	3	0	16	0	161
Grp Sat Flow(s),veh/h/ln	1781	1777	1585	1781	1777	1585	1225	1870	0	1414	0	1585
Q Serve(g_s), s	2.2	18.1	0.1	0.1	25.6	0.6	0.1	0.1	0.0	0.6	0.0	5.5
Cycle Q Clear(g_c), s	2.2	18.1	0.1	0.1	25.6	0.6	5.6	0.1	0.0	0.6	0.0	5.5
Prop In Lane	1.00		1.00	1.00		1.00	1.00		0.00	1.00		1.00
Lane Grp Cap(c), veh/h	89	1864	831	10	1704	760	335	502	0	486	0	426
V/C Ratio(X)	0.67	0.69	0.00	0.42	0.88	0.03	0.01	0.01	0.00	0.03	0.00	0.38
Avail Cap(c_a), veh/h	133	1864	831	133	1777	793	335	502	0	486	0	426
HCM Platoon Ratio	1.00	1.00	1.00	1.00	1.00	1.00	1.00	1.00	1.00	1.00	1.00	1.00
Upstream Filter(I)	1.00	1.00	1.00	1.00	1.00	1.00	1.00	1.00	0.00	1.00	0.00	1.00
Uniform Delay (d), s/veh	31.3	11.9	7.6	33.2	15.7	9.2	22.2	17.9	0.0	18.2	0.0	19.9
Incr Delay (d2), s/veh	8.4	1.1	0.0	26.7	5.5	0.0	0.0	0.0	0.0	0.1	0.0	2.5
Initial Q Delay(d3),s/veh	0.0	0.0	0.0	0.0	0.0	0.0	0.0	0.0	0.0	0.0	0.0	0.0
%ile BackOfQ(50%),veh/ln	1.1	6.3	0.0	0.1	10.2	0.2	0.0	0.0	0.0	0.2	0.0	2.2
Unsig. Movement Delay, s/veh												
LnGrp Delay(d),s/veh	39.7	13.0	7.6	59.9	21.2	9.2	22.3	18.0	0.0	18.3	0.0	22.5
LnGrp LOS	D	B	A	E	C	A	C	B	A	B	A	C
Approach Vol, veh/h		1351			1534			5				177
Approach Delay, s/veh		14.2			21.1			19.7				22.1
Approach LOS		B			C			B				C
Timer - Assigned Phs		2	3	4		6	7	8				
Phs Duration (G+Y+Rc), s		22.5	4.9	39.6		22.5	7.9	36.6				
Change Period (Y+Rc), s		4.5	4.5	4.5		4.5	4.5	4.5				
Max Green Setting (Gmax), s		18.0	5.0	33.5		18.0	5.0	33.5				
Max Q Clear Time (g_c+I1), s		7.6	2.1	20.1		7.5	4.2	27.6				
Green Ext Time (p_c), s		0.0	0.0	7.7		0.7	0.0	4.5				
Intersection Summary												
HCM 6th Ctrl Delay			18.1									
HCM 6th LOS			B									





















HCM 6th Signalized Intersection Summary
6: Av. La Pata/Antonio Pkwy & Ortega Hwy

08/02/2019

												
Movement	EBL	EBT	EBR	WBL	WBT	WBR	NBL	NBT	NBR	SBL	SBT	SBR
Lane Configurations	 	 			 		 	  			  	 
Traffic Volume (veh/h)	487	199	388	161	654	291	431	494	40	117	726	568
Future Volume (veh/h)	487	199	388	161	654	291	431	494	40	117	726	568
Initial Q (Qb), veh	0	0	0	0	0	0	0	0	0	0	0	0
Ped-Bike Adj(A_pbT)	1.00		1.00	1.00		1.00	1.00		1.00	1.00		1.00
Parking Bus, Adj	1.00	1.00	1.00	1.00	1.00	1.00	1.00	1.00	1.00	1.00	1.00	1.00
Work Zone On Approach		No			No			No			No	
Adj Sat Flow, veh/h/ln	1870	1870	1870	1870	1870	1870	1870	1870	1870	1870	1870	1870
Adj Flow Rate, veh/h	513	209	408	169	688	306	454	520	42	123	764	598
Peak Hour Factor	0.95	0.95	0.95	0.95	0.95	0.95	0.95	0.95	0.95	0.95	0.95	0.95
Percent Heavy Veh, %	2	2	2	2	2	2	2	2	2	2	2	2
Cap, veh/h	586	975	435	206	784	350	500	1513	470	155	1220	1140
Arrive On Green	0.17	0.27	0.27	0.12	0.22	0.22	0.14	0.30	0.30	0.09	0.24	0.24
Sat Flow, veh/h	3456	3554	1585	1781	3554	1585	3456	5106	1585	1781	5106	2790
Grp Volume(v), veh/h	513	209	408	169	688	306	454	520	42	123	764	598
Grp Sat Flow(s),veh/h/ln	1728	1777	1585	1781	1777	1585	1728	1702	1585	1781	1702	1395
Q Serve(g_s), s	11.5	3.6	20.0	7.4	14.9	14.8	10.3	6.3	1.5	5.4	10.7	12.8
Cycle Q Clear(g_c), s	11.5	3.6	20.0	7.4	14.9	14.8	10.3	6.3	1.5	5.4	10.7	12.8
Prop In Lane	1.00		1.00	1.00		1.00	1.00		1.00	1.00		1.00
Lane Grp Cap(c), veh/h	586	975	435	206	784	350	500	1513	470	155	1220	1140
V/C Ratio(X)	0.87	0.21	0.94	0.82	0.88	0.88	0.91	0.34	0.09	0.79	0.63	0.52
Avail Cap(c_a), veh/h	586	975	435	249	804	359	500	1513	470	193	1220	1140
HCM Platoon Ratio	1.00	1.00	1.00	1.00	1.00	1.00	1.00	1.00	1.00	1.00	1.00	1.00
Upstream Filter(I)	1.00	1.00	1.00	1.00	1.00	1.00	1.00	1.00	1.00	1.00	1.00	1.00
Uniform Delay (d), s/veh	32.2	22.2	28.2	34.3	30.0	29.9	33.5	21.9	20.2	35.6	27.1	17.7
Incr Delay (d2), s/veh	13.8	0.1	28.2	16.3	10.7	20.4	20.5	0.6	0.4	16.4	2.4	1.7
Initial Q Delay(d3),s/veh	0.0	0.0	0.0	0.0	0.0	0.0	0.0	0.0	0.0	0.0	0.0	0.0
%ile BackOfQ(50%),veh/ln	5.8	1.5	10.6	4.0	7.3	7.4	5.6	2.5	0.6	3.0	4.4	4.2
Unsig. Movement Delay, s/veh												
LnGrp Delay(d),s/veh	46.0	22.4	56.4	50.7	40.6	50.3	54.0	22.5	20.6	52.0	29.5	19.4
LnGrp LOS	D	C	E	D	D	D	D	C	C	D	C	B
Approach Vol, veh/h		1130			1163			1016			1485	
Approach Delay, s/veh		45.4			44.7			36.5			27.3	
Approach LOS		D			D			D			C	
Timer - Assigned Phs	1	2	3	4	5	6	7	8				
Phs Duration (G+Y+Rc), s	11.4	28.1	13.7	26.3	16.0	23.5	18.0	22.0				
Change Period (Y+Rc), s	4.5	4.5	4.5	4.5	4.5	4.5	4.5	4.5				
Max Green Setting (Gmax), s	8.6	21.9	11.1	20.4	11.5	19.0	13.5	18.0				
Max Q Clear Time (g_c+I1), s	7.4	8.3	9.4	22.0	12.3	14.8	13.5	16.9				
Green Ext Time (p_c), s	0.0	3.1	0.1	0.0	0.0	2.7	0.0	0.7				
Intersection Summary												
HCM 6th Ctrl Delay				37.7								
HCM 6th LOS				D								

HCM 6th Signalized Intersection Summary
 7: Av. La Pata & Stallion Ridge













08/02/2019

												
Movement	EBL	EBT	EBR	WBL	WBT	WBR	NBL	NBT	NBR	SBL	SBT	SBR
Lane Configurations												
Traffic Volume (veh/h)	551	0	109	7	0	19	178	466	4	20	495	819
Future Volume (veh/h)	551	0	109	7	0	19	178	466	4	20	495	819
Initial Q (Qb), veh	0	0	0	0	0	0	0	0	0	0	0	0
Ped-Bike Adj(A_pbT)	1.00		1.00	1.00		1.00	1.00		1.00	1.00		1.00
Parking Bus, Adj	1.00	1.00	1.00	1.00	1.00	1.00	1.00	1.00	1.00	1.00	1.00	1.00
Work Zone On Approach		No			No			No			No	
Adj Sat Flow, veh/h/ln	1870	1870	1870	1870	1870	1870	1870	1870	1870	1870	1870	1870
Adj Flow Rate, veh/h	580	0	115	7	0	20	187	491	4	21	521	0
Peak Hour Factor	0.95	0.95	0.95	0.95	0.95	0.95	0.95	0.95	0.95	0.95	0.95	0.95
Percent Heavy Veh, %	2	2	2	2	2	2	2	2	2	2	2	2
Cap, veh/h	699	0	314	124	0	104	228	1656	13	42	1809	
Arrive On Green	0.20	0.00	0.20	0.07	0.00	0.07	0.13	0.46	0.46	0.02	0.35	0.00
Sat Flow, veh/h	3456	0	1585	1781	0	1585	1781	3612	29	1781	5106	1585
Grp Volume(v), veh/h	580	0	115	7	0	20	187	241	254	21	521	0
Grp Sat Flow(s),veh/h/ln	1728	0	1585	1781	0	1585	1781	1777	1865	1781	1702	1585
Q Serve(g_s), s	11.6	0.0	4.5	0.3	0.0	0.9	7.4	6.1	6.1	0.8	5.3	0.0
Cycle Q Clear(g_c), s	11.6	0.0	4.5	0.3	0.0	0.9	7.4	6.1	6.1	0.8	5.3	0.0
Prop In Lane	1.00		1.00	1.00		1.00	1.00		0.02	1.00		1.00
Lane Grp Cap(c), veh/h	699	0	314	124	0	104	228	814	855	42	1809	
V/C Ratio(X)	0.83	0.00	0.37	0.06	0.00	0.19	0.82	0.30	0.30	0.49	0.29	
Avail Cap(c_a), veh/h	864	0	396	445	0	396	260	814	855	131	1809	
HCM Platoon Ratio	1.00	1.00	1.00	1.00	1.00	1.00	1.00	1.00	1.00	1.00	1.00	1.00
Upstream Filter(I)	1.00	0.00	1.00	1.00	0.00	1.00	1.00	1.00	1.00	1.00	1.00	0.00
Uniform Delay (d), s/veh	27.5	0.0	24.9	31.3	0.0	31.8	30.6	12.2	12.2	34.7	16.7	0.0
Incr Delay (d2), s/veh	5.6	0.0	0.7	0.2	0.0	0.9	16.9	0.9	0.9	8.7	0.4	0.0
Initial Q Delay(d3),s/veh	0.0	0.0	0.0	0.0	0.0	0.0	0.0	0.0	0.0	0.0	0.0	0.0
%ile BackOfQ(50%),veh/ln	5.1	0.0	1.7	0.1	0.0	0.3	4.1	2.4	2.5	0.5	2.0	0.0
Unsig. Movement Delay, s/veh												
LnGrp Delay(d),s/veh	33.1	0.0	25.6	31.5	0.0	32.7	47.4	13.2	13.1	43.4	17.1	0.0
LnGrp LOS	C	A	C	C	A	C	D	B	B	D	B	
Approach Vol, veh/h		695			27			682			542	A
Approach Delay, s/veh		31.9			32.4			22.5			18.1	
Approach LOS		C			C			C			B	
Timer - Assigned Phs	1	2	3	4	5	6	7	8				
Phs Duration (G+Y+Rc), s	6.2	37.5	9.5	18.8	13.7	30.0	19.1	9.2				
Change Period (Y+Rc), s	4.5	4.5	4.5	4.5	4.5	4.5	4.5	4.5				
Max Green Setting (Gmax), s	5.3	30.7	18.0	18.0	10.5	25.5	18.0	18.0				
Max Q Clear Time (g_c+I1), s	2.8	8.1	2.3	6.5	9.4	7.3	13.6	2.9				
Green Ext Time (p_c), s	0.0	3.0	0.0	0.4	0.1	3.4	1.0	0.0				
Intersection Summary												
HCM 6th Ctrl Delay			24.8									
HCM 6th LOS			C									
Notes												
Unsignalized Delay for [SBR] is excluded from calculations of the approach delay and intersection delay.												

HCM 6th Signalized Intersection Summary

1: Ortega & I-5 SB Off-Ramp

08/02/2019

												
Movement	EBL	EBT	EBR	WBL	WBT	WBR	NBL	NBT	NBR	SBL	SBT	SBR
Lane Configurations		↑↑↑	↗	↖↗	↑↑					↖↗		↖↗
Traffic Volume (veh/h)	0	1084	172	403	708	0	0	0	0	1020	0	746
Future Volume (veh/h)	0	1084	172	403	708	0	0	0	0	1020	0	746
Initial Q (Qb), veh	0	0	0	0	0	0				0	0	0
Ped-Bike Adj(A_pbT)	1.00		1.00	1.00		1.00				1.00		1.00
Parking Bus, Adj	1.00	1.00	1.00	1.00	1.00	1.00				1.00	1.00	1.00
Work Zone On Approach		No			No						No	
Adj Sat Flow, veh/h/ln	0	1870	1870	1870	1870	0				1870	0	1870
Adj Flow Rate, veh/h	0	1141	0	424	745	0				1074	0	785
Peak Hour Factor	0.95	0.95	0.95	0.95	0.95	0.95				0.95	0.95	0.95
Percent Heavy Veh, %	0	2	2	2	2	0				2	0	2
Cap, veh/h	0	1358		505	1711	0				1314	0	1061
Arrive On Green	0.00	0.27	0.00	0.15	0.48	0.00				0.38	0.00	0.38
Sat Flow, veh/h	0	5274	1585	3456	3647	0				3456	0	2790
Grp Volume(v), veh/h	0	1141	0	424	745	0				1074	0	785
Grp Sat Flow(s),veh/h/ln	0	1702	1585	1728	1777	0				1728	0	1395
Q Serve(g_s), s	0.0	13.7	0.0	7.8	8.9	0.0				18.2	0.0	15.8
Cycle Q Clear(g_c), s	0.0	13.7	0.0	7.8	8.9	0.0				18.2	0.0	15.8
Prop In Lane	0.00		1.00	1.00		0.00				1.00		1.00
Lane Grp Cap(c), veh/h	0	1358		505	1711	0				1314	0	1061
V/C Ratio(X)	0.00	0.84		0.84	0.44	0.00				0.82	0.00	0.74
Avail Cap(c_a), veh/h	0	1414		505	1750	0				1314	0	1061
HCM Platoon Ratio	1.00	1.00	1.00	1.00	1.00	1.00				1.00	1.00	1.00
Upstream Filter(I)	0.00	1.00	0.00	1.00	1.00	0.00				1.00	0.00	1.00
Uniform Delay (d), s/veh	0.0	22.5	0.0	27.0	11.1	0.0				18.1	0.0	17.4
Incr Delay (d2), s/veh	0.0	4.6	0.0	12.0	0.2	0.0				4.2	0.0	2.8
Initial Q Delay(d3),s/veh	0.0	0.0	0.0	0.0	0.0	0.0				0.0	0.0	0.0
%ile BackOfQ(50%),veh/ln	0.0	5.7	0.0	3.9	3.1	0.0				7.2	0.0	4.9
Unsig. Movement Delay, s/veh												
LnGrp Delay(d),s/veh	0.0	27.1	0.0	39.0	11.2	0.0				22.3	0.0	20.2
LnGrp LOS	A	C		D	B	A				C	A	C
Approach Vol, veh/h		1141	A		1169						1859	
Approach Delay, s/veh		27.1			21.3						21.4	
Approach LOS		C			C						C	
Timer - Assigned Phs			3	4		6			8			
Phs Duration (G+Y+Rc), s			14.0	21.8		29.2			35.8			
Change Period (Y+Rc), s			4.5	4.5		4.5			4.5			
Max Green Setting (Gmax), s			9.5	18.0		24.0			32.0			
Max Q Clear Time (g_c+I1), s			9.8	15.7		20.2			10.9			
Green Ext Time (p_c), s			0.0	1.6		2.7			5.3			
Intersection Summary												
HCM 6th Ctrl Delay			22.9									
HCM 6th LOS			C									
Notes												
Unsignalized Delay for [EBR] is excluded from calculations of the approach delay and intersection delay.												

HCM 6th Signalized Intersection Summary
 2: I-5 NB Ramps & Ortega

08/02/2019



Movement	EBL	EBT	EBR	WBL	WBT	WBR	NBL	NBT	NBR	SBL	SBT	SBR
Lane Configurations												
Traffic Volume (veh/h)	48	1522	536	0	1823	82	164	18	391	40	0	116
Future Volume (veh/h)	48	1522	536	0	1823	82	164	18	391	40	0	116
Initial Q (Qb), veh	0	0	0	0	0	0	0	0	0	0	0	0
Ped-Bike Adj(A_pbT)	1.00		1.00	1.00		1.00	1.00		1.00	1.00		1.00
Parking Bus, Adj	1.00	1.00	1.00	1.00	1.00	1.00	1.00	1.00	1.00	1.00	1.00	1.00
Work Zone On Approach		No			No			No			No	
Adj Sat Flow, veh/h/ln	1870	1870	1870	0	1870	1870	1870	1870	1870	1870	1870	1870
Adj Flow Rate, veh/h	51	1636	542	0	1919	86	173	184	302	42	0	122
Peak Hour Factor	0.95	0.95	0.95	0.95	0.95	0.95	0.95	0.95	0.95	0.95	0.95	0.95
Percent Heavy Veh, %	2	2	2	0	2	2	2	2	2	2	2	2
Cap, veh/h	67	2625	742	0	1929	86	265	282	476	173	182	154
Arrive On Green	0.04	0.47	0.47	0.00	0.39	0.39	0.30	0.30	0.30	0.10	0.00	0.10
Sat Flow, veh/h	1781	5611	1585	0	5178	224	885	941	1585	1781	1870	1585
Grp Volume(v), veh/h	51	1636	542	0	1303	702	357	0	302	42	0	122
Grp Sat Flow(s),veh/h/ln	1781	1870	1585	0	1702	1830	1826	0	1585	1781	1870	1585
Q Serve(g_s), s	2.8	21.9	27.7	0.0	38.1	38.3	17.0	0.0	16.5	2.2	0.0	7.5
Cycle Q Clear(g_c), s	2.8	21.9	27.7	0.0	38.1	38.3	17.0	0.0	16.5	2.2	0.0	7.5
Prop In Lane	1.00		1.00	0.00		0.12	0.48		1.00	1.00		1.00
Lane Grp Cap(c), veh/h	67	2625	742	0	1311	705	548	0	476	173	182	154
V/C Ratio(X)	0.76	0.62	0.73	0.00	0.99	1.00	0.65	0.00	0.64	0.24	0.00	0.79
Avail Cap(c_a), veh/h	94	2710	766	0	1311	705	548	0	476	322	339	287
HCM Platoon Ratio	1.00	1.00	1.00	1.00	1.00	1.00	1.00	1.00	1.00	1.00	1.00	1.00
Upstream Filter(I)	1.00	1.00	1.00	0.00	1.00	1.00	1.00	0.00	1.00	1.00	0.00	1.00
Uniform Delay (d), s/veh	47.6	20.0	21.5	0.0	30.6	30.7	30.5	0.0	30.3	41.7	0.0	44.2
Incr Delay (d2), s/veh	19.6	0.4	3.5	0.0	23.3	33.1	5.9	0.0	6.3	0.7	0.0	8.8
Initial Q Delay(d3),s/veh	0.0	0.0	0.0	0.0	0.0	0.0	0.0	0.0	0.0	0.0	0.0	0.0
%ile BackOfQ(50%),veh/ln	1.6	9.3	10.5	0.0	19.2	22.7	8.2	0.0	7.0	1.0	0.0	6.8
Unsig. Movement Delay, s/veh												
LnGrp Delay(d),s/veh	67.2	20.4	25.0	0.0	54.0	63.8	36.4	0.0	36.6	42.5	0.0	53.0
LnGrp LOS	E	C	C	A	D	E	D	A	D	D	A	D
Approach Vol, veh/h		2229			2005			659				164
Approach Delay, s/veh		22.6			57.4			36.5				50.3
Approach LOS		C			E			D				D
Timer - Assigned Phs		2		4		6	7	8				
Phs Duration (G+Y+Rc), s		34.5		51.3		14.2	8.3	43.0				
Change Period (Y+Rc), s		4.5		4.5		4.5	4.5	4.5				
Max Green Setting (Gmax), s		20.1		48.3		18.1	5.3	38.5				
Max Q Clear Time (g_c+I1), s		19.0		29.7		9.5	4.8	40.3				
Green Ext Time (p_c), s		0.4		13.5		0.3	0.0	0.0				

Intersection Summary

HCM 6th Ctrl Delay	39.1
HCM 6th LOS	D

Notes

User approved volume balancing among the lanes for turning movement.

HCM 6th Signalized Intersection Summary
 3: Rancho Viejo & Ortega

08/02/2019



Movement	EBL	EBT	EBR	WBL	WBT	WBR	NBL	NBT	NBR	SBL	SBT	SBR
Lane Configurations	↵	↑↑	↶	↵	↑↑↑	↶	↵	↶↷		↵	↶↷	
Traffic Volume (veh/h)	161	1443	358	49	1128	214	420	106	97	275	125	277
Future Volume (veh/h)	161	1443	358	49	1128	214	420	106	97	275	125	277
Initial Q (Qb), veh	0	0	0	0	0	0	0	0	0	0	0	0
Ped-Bike Adj(A_pbT)	1.00		1.00	1.00		1.00	1.00		1.00	1.00		1.00
Parking Bus, Adj	1.00	1.00	1.00	1.00	1.00	1.00	1.00	1.00	1.00	1.00	1.00	1.00
Work Zone On Approach		No			No			No			No	
Adj Sat Flow, veh/h/ln	1870	1870	1870	1870	1870	1870	1870	1870	1870	1870	1870	1870
Adj Flow Rate, veh/h	169	1519	377	52	1187	225	442	112	102	238	204	292
Peak Hour Factor	0.95	0.95	0.95	0.95	0.95	0.95	0.95	0.95	0.95	0.95	0.95	0.95
Percent Heavy Veh, %	2	2	2	2	2	2	2	2	2	2	2	2
Cap, veh/h	201	1439	954	68	1687	524	701	177	162	321	337	285
Arrive On Green	0.11	0.41	0.41	0.04	0.33	0.33	0.20	0.20	0.20	0.18	0.18	0.18
Sat Flow, veh/h	1781	3554	1585	1781	5106	1585	3563	902	821	1781	1870	1585
Grp Volume(v), veh/h	169	1519	377	52	1187	225	442	0	214	238	204	292
Grp Sat Flow(s),veh/h/ln	1781	1777	1585	1781	1702	1585	1781	0	1723	1781	1870	1585
Q Serve(g_s), s	9.3	40.5	12.4	2.9	20.3	11.1	11.4	0.0	11.4	12.6	10.0	18.0
Cycle Q Clear(g_c), s	9.3	40.5	12.4	2.9	20.3	11.1	11.4	0.0	11.4	12.6	10.0	18.0
Prop In Lane	1.00		1.00	1.00		1.00	1.00		0.48	1.00		1.00
Lane Grp Cap(c), veh/h	201	1439	954	68	1687	524	701	0	339	321	337	285
V/C Ratio(X)	0.84	1.06	0.40	0.76	0.70	0.43	0.63	0.00	0.63	0.74	0.61	1.02
Avail Cap(c_a), veh/h	237	1439	954	89	1687	524	701	0	339	321	337	285
HCM Platoon Ratio	1.00	1.00	1.00	1.00	1.00	1.00	1.00	1.00	1.00	1.00	1.00	1.00
Upstream Filter(I)	1.00	1.00	1.00	1.00	1.00	1.00	1.00	0.00	1.00	1.00	1.00	1.00
Uniform Delay (d), s/veh	43.5	29.7	10.4	47.6	29.2	26.1	36.8	0.0	36.8	38.8	37.7	41.0
Incr Delay (d2), s/veh	20.3	39.8	0.3	24.2	1.3	0.6	4.3	0.0	8.6	8.9	3.1	59.4
Initial Q Delay(d3),s/veh	0.0	0.0	0.0	0.0	0.0	0.0	0.0	0.0	0.0	0.0	0.0	0.0
%ile BackOfQ(50%),veh/ln	5.2	24.5	6.8	1.7	8.3	4.2	5.3	0.0	5.6	6.3	4.8	11.6
Unsig. Movement Delay, s/veh												
LnGrp Delay(d),s/veh	63.8	69.6	10.7	71.9	30.5	26.7	41.1	0.0	45.5	47.8	40.8	100.4
LnGrp LOS	E	F	B	E	C	C	D	A	D	D	D	F
Approach Vol, veh/h		2065			1464			656				734
Approach Delay, s/veh		58.4			31.4			42.5				66.8
Approach LOS		E			C			D				E
Timer - Assigned Phs		2	3	4		6	7	8				
Phs Duration (G+Y+Rc), s		24.2	8.3	45.0		22.5	15.8	37.5				
Change Period (Y+Rc), s		4.5	4.5	4.5		4.5	4.5	4.5				
Max Green Setting (Gmax), s		18.5	5.0	40.5		18.0	13.3	32.2				
Max Q Clear Time (g_c+I1), s		13.4	4.9	42.5		20.0	11.3	22.3				
Green Ext Time (p_c), s		1.4	0.0	0.0		0.0	0.1	6.1				

Intersection Summary

HCM 6th Ctrl Delay	49.5
HCM 6th LOS	D

Notes

User approved volume balancing among the lanes for turning movement.

HCM 6th Signalized Intersection Summary

4: La Novia & Ortega

08/02/2019

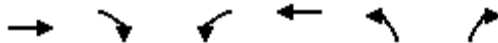

Movement	EBT	EBR	WBL	WBT	NBL	NBR
Lane Configurations	↑↑	↑	↓	↑↑	↓	↓
Traffic Volume (veh/h)	1519	176	129	1054	240	167
Future Volume (veh/h)	1519	176	129	1054	240	167
Initial Q (Qb), veh	0	0	0	0	0	0
Ped-Bike Adj(A_pbT)		1.00	1.00		1.00	1.00
Parking Bus, Adj	1.00	1.00	1.00	1.00	1.00	1.00
Work Zone On Approach	No			No	No	
Adj Sat Flow, veh/h/ln	1870	1870	1870	1870	1870	1870
Adj Flow Rate, veh/h	1599	185	136	1109	253	176
Peak Hour Factor	0.95	0.95	0.95	0.95	0.95	0.95
Percent Heavy Veh, %	2	2	2	2	2	2
Cap, veh/h	1728	771	169	2266	863	396
Arrive On Green	0.49	0.49	0.10	0.64	0.25	0.25
Sat Flow, veh/h	3647	1585	1781	3647	3456	1585
Grp Volume(v), veh/h	1599	185	136	1109	253	176
Grp Sat Flow(s),veh/h/ln	1777	1585	1781	1777	1728	1585
Q Serve(g_s), s	33.6	5.4	6.0	13.2	4.7	7.5
Cycle Q Clear(g_c), s	33.6	5.4	6.0	13.2	4.7	7.5
Prop In Lane		1.00	1.00		1.00	1.00
Lane Grp Cap(c), veh/h	1728	771	169	2266	863	396
V/C Ratio(X)	0.93	0.24	0.80	0.49	0.29	0.44
Avail Cap(c_a), veh/h	1755	783	189	2332	863	396
HCM Platoon Ratio	1.00	1.00	1.00	1.00	1.00	1.00
Upstream Filter(I)	1.00	1.00	1.00	1.00	1.00	1.00
Uniform Delay (d), s/veh	19.2	12.0	35.5	7.6	24.3	25.3
Incr Delay (d2), s/veh	8.8	0.2	19.7	0.2	0.9	3.6
Initial Q Delay(d3),s/veh	0.0	0.0	0.0	0.0	0.0	0.0
%ile BackOfQ(50%),veh/ln	14.5	1.8	3.5	4.2	2.0	3.1
Unsig. Movement Delay, s/veh						
LnGrp Delay(d),s/veh	28.0	12.1	55.2	7.8	25.1	28.9
LnGrp LOS	C	B	E	A	C	C
Approach Vol, veh/h	1784			1245	429	
Approach Delay, s/veh	26.4			13.0	26.7	
Approach LOS	C			B	C	
Timer - Assigned Phs		2	3	4		8
Phs Duration (G+Y+Rc), s		24.5	12.1	43.4		55.5
Change Period (Y+Rc), s		4.5	4.5	4.5		4.5
Max Green Setting (Gmax), s		18.5	8.5	39.5		52.5
Max Q Clear Time (g_c+I1), s		9.5	8.0	35.6		15.2
Green Ext Time (p_c), s		1.1	0.0	3.3		10.4
Intersection Summary						
HCM 6th Ctrl Delay			21.6			
HCM 6th LOS			C			

HCM 6th Signalized Intersection Summary
5: Reata Rd & Ortega Hwy































08/02/2019



Movement	EBL	EBT	EBR	WBL	WBT	WBR	NBL	NBT	NBR	SBL	SBT	SBR
Lane Configurations	↖	↗	↘	↖	↗	↘	↖	↗	↘	↖	↗	↘
Traffic Volume (veh/h)	81	1528	3	10	1029	14	2	0	4	29	0	96
Future Volume (veh/h)	81	1528	3	10	1029	14	2	0	4	29	0	96
Initial Q (Qb), veh	0	0	0	0	0	0	0	0	0	0	0	0
Ped-Bike Adj(A_pbT)	1.00		1.00	1.00		1.00	1.00		1.00	1.00		1.00
Parking Bus, Adj	1.00	1.00	1.00	1.00	1.00	1.00	1.00	1.00	1.00	1.00	1.00	1.00
Work Zone On Approach		No			No			No			No	
Adj Sat Flow, veh/h/ln	1870	1870	1870	1870	1870	1870	1870	1870	1870	1870	1870	1870
Adj Flow Rate, veh/h	85	1608	3	11	1083	15	2	0	4	31	0	101
Peak Hour Factor	0.95	0.95	0.95	0.95	0.95	0.95	0.95	0.95	0.95	0.95	0.95	0.95
Percent Heavy Veh, %	2	2	2	2	2	2	2	2	2	2	2	2
Cap, veh/h	109	1783	795	25	1614	720	405	0	439	499	0	439
Arrive On Green	0.06	0.50	0.50	0.01	0.45	0.45	0.28	0.00	0.28	0.28	0.00	0.28
Sat Flow, veh/h	1781	3554	1585	1781	3554	1585	1294	0	1585	1412	0	1585
Grp Volume(v), veh/h	85	1608	3	11	1083	15	2	0	4	31	0	101
Grp Sat Flow(s),veh/h/ln	1781	1777	1585	1781	1777	1585	1294	0	1585	1412	0	1585
Q Serve(g_s), s	3.1	26.8	0.1	0.4	15.6	0.3	0.1	0.0	0.1	1.1	0.0	3.2
Cycle Q Clear(g_c), s	3.1	26.8	0.1	0.4	15.6	0.3	3.3	0.0	0.1	1.2	0.0	3.2
Prop In Lane	1.00		1.00	1.00		1.00	1.00		1.00	1.00		1.00
Lane Grp Cap(c), veh/h	109	1783	795	25	1614	720	405	0	439	499	0	439
V/C Ratio(X)	0.78	0.90	0.00	0.45	0.67	0.02	0.00	0.00	0.01	0.06	0.00	0.23
Avail Cap(c_a), veh/h	167	1831	817	137	1771	790	405	0	439	499	0	439
HCM Platoon Ratio	1.00	1.00	1.00	1.00	1.00	1.00	1.00	1.00	1.00	1.00	1.00	1.00
Upstream Filter(I)	1.00	1.00	1.00	1.00	1.00	1.00	1.00	0.00	1.00	1.00	0.00	1.00
Uniform Delay (d), s/veh	30.1	14.7	8.1	31.8	13.9	9.8	19.4	0.0	17.0	17.5	0.0	18.2
Incr Delay (d2), s/veh	11.9	6.5	0.0	12.1	0.9	0.0	0.0	0.0	0.0	0.2	0.0	1.2
Initial Q Delay(d3),s/veh	0.0	0.0	0.0	0.0	0.0	0.0	0.0	0.0	0.0	0.0	0.0	0.0
%ile BackOfQ(50%),veh/ln	1.6	10.6	0.0	0.2	5.6	0.1	0.0	0.0	0.0	0.4	0.0	1.2
Unsig. Movement Delay, s/veh												
LnGrp Delay(d),s/veh	42.0	21.3	8.1	43.9	14.8	9.8	19.4	0.0	17.1	17.7	0.0	19.4
LnGrp LOS	D	C	A	D	B	A	B	A	B	B	A	B
Approach Vol, veh/h		1696			1109			6				132
Approach Delay, s/veh		22.3			15.0			17.9				19.0
Approach LOS		C			B			B				B
Timer - Assigned Phs		2	3	4		6	7	8				
Phs Duration (G+Y+Rc), s		22.5	5.4	37.1		22.5	8.5	34.0				
Change Period (Y+Rc), s		4.5	4.5	4.5		4.5	4.5	4.5				
Max Green Setting (Gmax), s		18.0	5.0	33.5		18.0	6.1	32.4				
Max Q Clear Time (g_c+I1), s		5.3	2.4	28.8		5.2	5.1	17.6				
Green Ext Time (p_c), s		0.0	0.0	3.8		0.5	0.0	6.9				
Intersection Summary												
HCM 6th Ctrl Delay				19.4								
HCM 6th LOS				B								

HCM 6th Signalized Intersection Summary
 6: Av. La Pata/Antonio Pkwy & Ortega Hwy

08/02/2019

												
Movement	EBL	EBT	EBR	WBL	WBT	WBR	NBL	NBT	NBR	SBL	SBT	SBR
Lane Configurations	 	 			 		 	  		  		
Traffic Volume (veh/h)	514	832	226	73	293	109	306	528	127	282	442	529
Future Volume (veh/h)	514	832	226	73	293	109	306	528	127	282	442	529
Initial Q (Qb), veh	0	0	0	0	0	0	0	0	0	0	0	0
Ped-Bike Adj(A_pbT)	1.00		1.00	1.00		1.00	1.00		1.00	1.00		1.00
Parking Bus, Adj	1.00	1.00	1.00	1.00	1.00	1.00	1.00	1.00	1.00	1.00	1.00	1.00
Work Zone On Approach		No			No			No			No	
Adj Sat Flow, veh/h/ln	1870	1870	1870	1870	1870	1870	1870	1870	1870	1870	1870	1870
Adj Flow Rate, veh/h	541	876	238	77	308	115	322	556	134	297	465	557
Peak Hour Factor	0.95	0.95	0.95	0.95	0.95	0.95	0.95	0.95	0.95	0.95	0.95	0.95
Percent Heavy Veh, %	2	2	2	2	2	2	2	2	2	2	2	2
Cap, veh/h	630	1069	477	99	618	276	418	1190	369	338	1542	1352
Arrive On Green	0.18	0.30	0.30	0.06	0.17	0.17	0.12	0.23	0.23	0.19	0.30	0.30
Sat Flow, veh/h	3456	3554	1585	1781	3554	1585	3456	5106	1585	1781	5106	2790
Grp Volume(v), veh/h	541	876	238	77	308	115	322	556	134	297	465	557
Grp Sat Flow(s),veh/h/ln	1728	1777	1585	1781	1777	1585	1728	1702	1585	1781	1702	1395
Q Serve(g_s), s	12.4	18.7	10.1	3.5	6.4	5.3	7.4	7.6	5.8	13.2	5.7	10.5
Cycle Q Clear(g_c), s	12.4	18.7	10.1	3.5	6.4	5.3	7.4	7.6	5.8	13.2	5.7	10.5
Prop In Lane	1.00		1.00	1.00		1.00	1.00		1.00	1.00		1.00
Lane Grp Cap(c), veh/h	630	1069	477	99	618	276	418	1190	369	338	1542	1352
V/C Ratio(X)	0.86	0.82	0.50	0.78	0.50	0.42	0.77	0.47	0.36	0.88	0.30	0.41
Avail Cap(c_a), veh/h	699	1216	542	144	784	350	597	1190	369	404	1542	1352
HCM Platoon Ratio	1.00	1.00	1.00	1.00	1.00	1.00	1.00	1.00	1.00	1.00	1.00	1.00
Upstream Filter(I)	1.00	1.00	1.00	1.00	1.00	1.00	1.00	1.00	1.00	1.00	1.00	1.00
Uniform Delay (d), s/veh	32.3	26.5	23.5	38.0	30.5	30.0	34.8	26.9	26.2	32.1	21.9	13.5
Incr Delay (d2), s/veh	9.7	4.1	0.8	14.9	0.6	1.0	3.9	1.3	2.7	17.0	0.5	0.9
Initial Q Delay(d3),s/veh	0.0	0.0	0.0	0.0	0.0	0.0	0.0	0.0	0.0	0.0	0.0	0.0
%ile BackOfQ(50%),veh/ln	5.9	8.1	3.7	1.9	2.7	2.0	3.2	3.2	2.4	7.1	2.3	3.2
Unsig. Movement Delay, s/veh												
LnGrp Delay(d),s/veh	42.0	30.6	24.3	52.9	31.1	31.0	38.6	28.2	29.0	49.1	22.4	14.5
LnGrp LOS	D	C	C	D	C	C	D	C	C	D	C	B
Approach Vol, veh/h		1655			500			1012			1319	
Approach Delay, s/veh		33.4			34.4			31.6			25.1	
Approach LOS		C			C			C			C	
Timer - Assigned Phs	1	2	3	4	5	6	7	8				
Phs Duration (G+Y+Rc), s	20.0	23.5	9.0	29.0	14.4	29.1	19.4	18.7				
Change Period (Y+Rc), s	4.5	4.5	4.5	4.5	4.5	4.5	4.5	4.5				
Max Green Setting (Gmax), s	18.5	19.0	6.6	27.9	14.1	23.4	16.5	18.0				
Max Q Clear Time (g_c+I1), s	15.2	9.6	5.5	20.7	9.4	12.5	14.4	8.4				
Green Ext Time (p_c), s	0.3	2.9	0.0	3.9	0.5	4.2	0.5	1.6				
Intersection Summary												
HCM 6th Ctrl Delay			30.7									
HCM 6th LOS			C									

HCM 6th Signalized Intersection Summary
 7: Av. La Pata & Stallion Ridge

08/02/2019



Movement	EBL	EBT	EBR	WBL	WBT	WBR	NBL	NBT	NBR	SBL	SBT	SBR
Lane Configurations	↔↔	↔		↔	↔		↔	↕↔		↔	↕↕↕	↔
Traffic Volume (veh/h)	159	0	46	4	0	16	31	670	1	9	495	268
Future Volume (veh/h)	159	0	46	4	0	16	31	670	1	9	495	268
Initial Q (Qb), veh	0	0	0	0	0	0	0	0	0	0	0	0
Ped-Bike Adj(A_pbT)	1.00		1.00	1.00		1.00	1.00		1.00	1.00		1.00
Parking Bus, Adj	1.00	1.00	1.00	1.00	1.00	1.00	1.00	1.00	1.00	1.00	1.00	1.00
Work Zone On Approach		No			No			No			No	
Adj Sat Flow, veh/h/ln	1870	1870	1870	1870	1870	1870	1870	1870	1870	1870	1870	1870
Adj Flow Rate, veh/h	167	0	48	4	0	17	33	705	1	9	521	0
Peak Hour Factor	0.95	0.95	0.95	0.95	0.95	0.95	0.95	0.95	0.95	0.95	0.95	0.95
Percent Heavy Veh, %	2	2	2	2	2	2	2	2	2	2	2	2
Cap, veh/h	332	0	153	166	0	149	66	1583	2	21	2092	
Arrive On Green	0.10	0.00	0.10	0.09	0.00	0.09	0.04	0.43	0.43	0.01	0.41	0.00
Sat Flow, veh/h	3456	0	1585	1781	0	1585	1781	3641	5	1781	5106	1585
Grp Volume(v), veh/h	167	0	48	4	0	17	33	344	362	9	521	0
Grp Sat Flow(s),veh/h/ln	1728	0	1585	1781	0	1585	1781	1777	1869	1781	1702	1585
Q Serve(g_s), s	2.3	0.0	1.4	0.1	0.0	0.5	0.9	6.7	6.7	0.2	3.3	0.0
Cycle Q Clear(g_c), s	2.3	0.0	1.4	0.1	0.0	0.5	0.9	6.7	6.7	0.2	3.3	0.0
Prop In Lane	1.00		1.00	1.00		1.00	1.00		0.00	1.00		1.00
Lane Grp Cap(c), veh/h	332	0	153	166	0	149	66	773	813	21	2092	
V/C Ratio(X)	0.50	0.00	0.31	0.02	0.00	0.11	0.50	0.45	0.45	0.43	0.25	
Avail Cap(c_a), veh/h	1256	0	576	647	0	576	205	773	813	180	2092	
HCM Platoon Ratio	1.00	1.00	1.00	1.00	1.00	1.00	1.00	1.00	1.00	1.00	1.00	1.00
Upstream Filter(I)	1.00	0.00	1.00	1.00	0.00	1.00	1.00	1.00	1.00	1.00	1.00	0.00
Uniform Delay (d), s/veh	21.3	0.0	20.8	20.4	0.0	20.5	23.4	9.8	9.8	24.3	9.6	0.0
Incr Delay (d2), s/veh	1.2	0.0	1.2	0.1	0.0	0.3	5.8	1.9	1.8	13.3	0.3	0.0
Initial Q Delay(d3),s/veh	0.0	0.0	0.0	0.0	0.0	0.0	0.0	0.0	0.0	0.0	0.0	0.0
%ile BackOfQ(50%),veh/ln	0.9	0.0	0.5	0.0	0.0	0.2	0.5	2.5	2.6	0.2	1.1	0.0
Unsig. Movement Delay, s/veh												
LnGrp Delay(d),s/veh	22.5	0.0	22.0	20.5	0.0	20.9	29.3	11.7	11.6	37.6	9.9	0.0
LnGrp LOS	C	A	C	C	A	C	C	B	B	D	A	
Approach Vol, veh/h		215			21			739			530	A
Approach Delay, s/veh		22.4			20.8			12.4			10.4	
Approach LOS		C			C			B			B	
Timer - Assigned Phs	1	2	3	4	5	6	7	8				
Phs Duration (G+Y+Rc), s	5.1	26.0	9.1	9.3	6.3	24.8	9.3	9.2				
Change Period (Y+Rc), s	4.5	4.5	4.5	4.5	4.5	4.5	4.5	4.5				
Max Green Setting (Gmax), s	5.0	21.0	18.0	18.0	5.7	20.3	18.0	18.0				
Max Q Clear Time (g_c+I1), s	2.2	8.7	2.1	3.4	2.9	5.3	4.3	2.5				
Green Ext Time (p_c), s	0.0	3.5	0.0	0.1	0.0	3.1	0.4	0.0				

Intersection Summary

HCM 6th Ctrl Delay	13.2
HCM 6th LOS	B

Notes

Unsignalized Delay for [SBR] is excluded from calculations of the approach delay and intersection delay.